

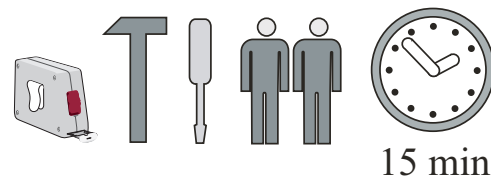

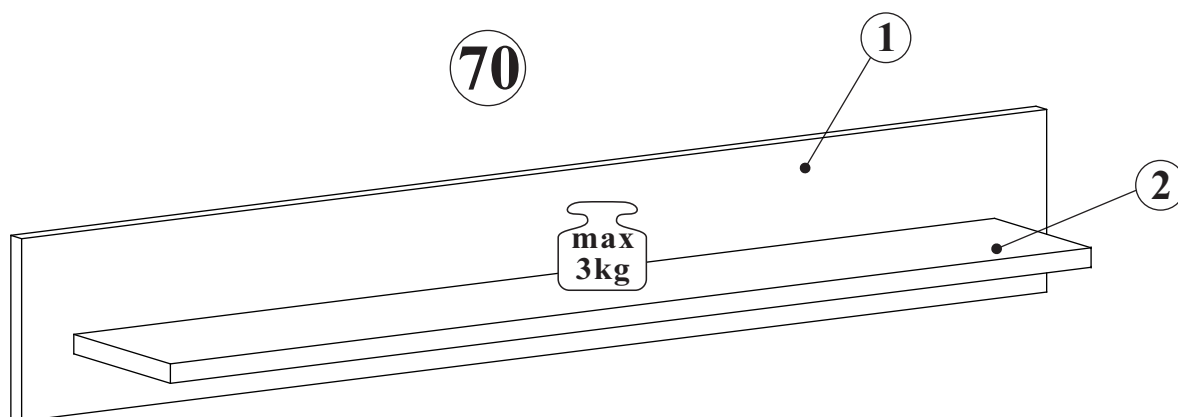

CHECK TYP 70

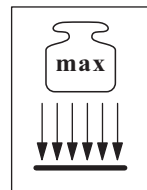
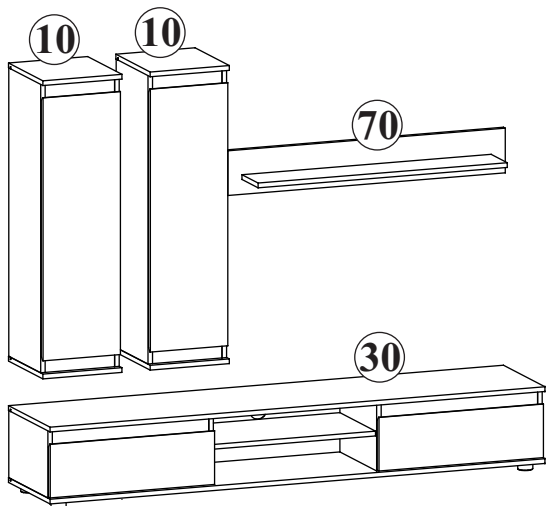
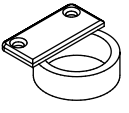

NO	Dim.	Col.-No	Qty
1	982 150	2	1
2	882 144	2	1

CHECK TYP 70

ZWA		D10		B11		G2	
x2		x4	USØ3,5x13	x4	Ø7x50	x1	

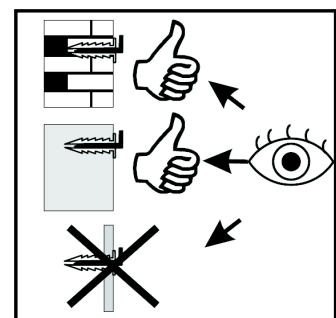
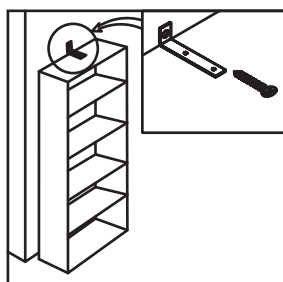
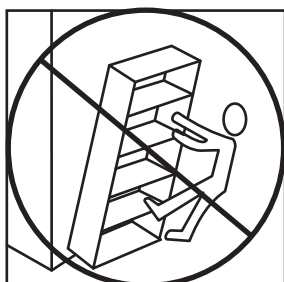
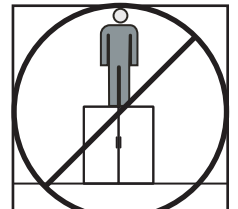
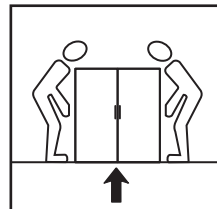
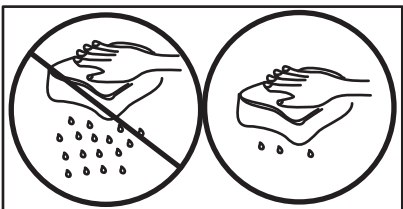
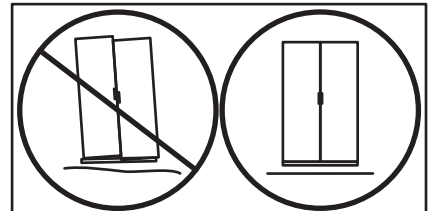
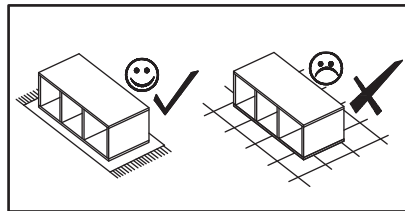
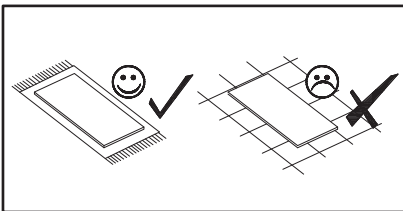
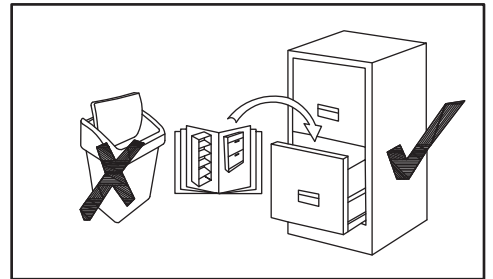
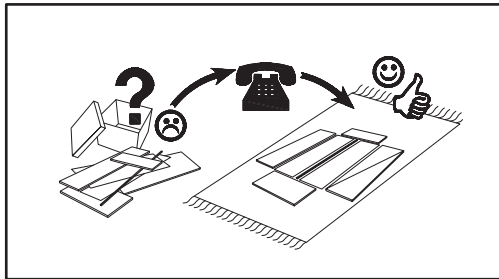
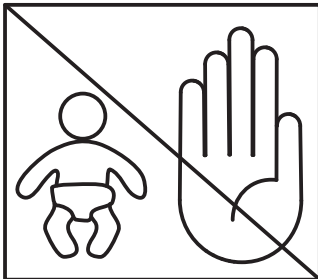
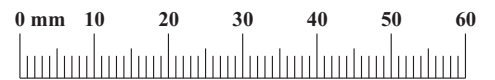

CHECK TYP 70

1

ZWA		D10	
x2		x4	US03,5x13

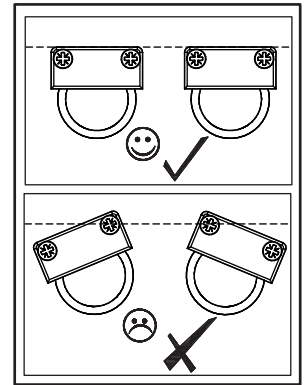
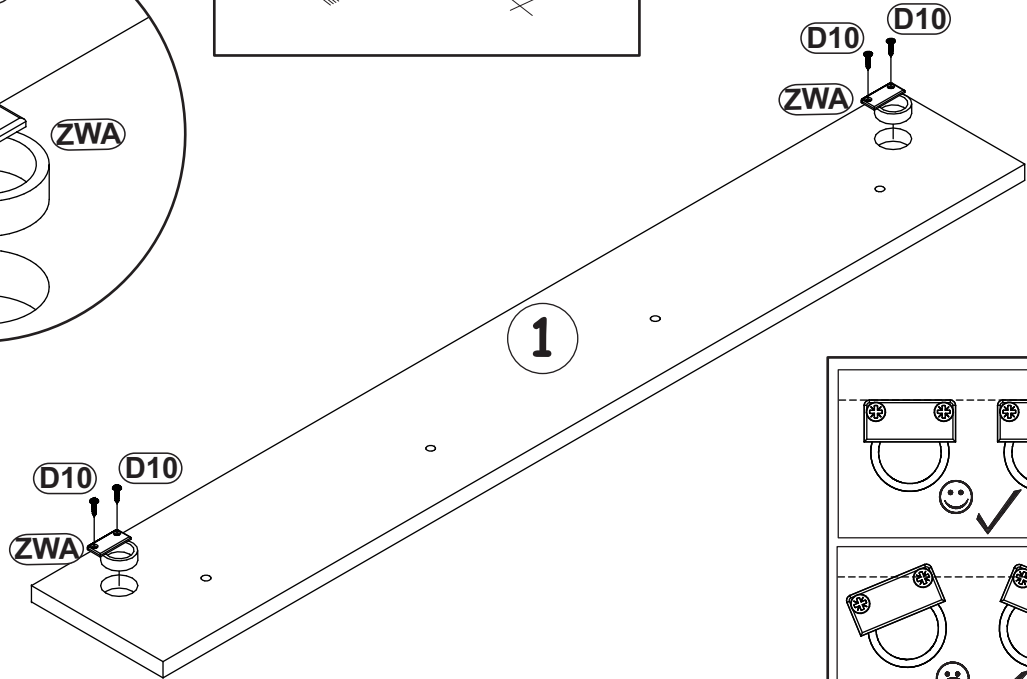
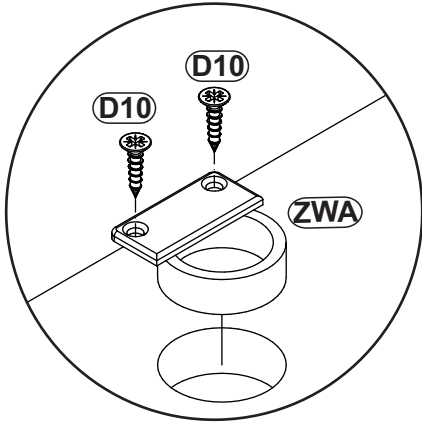
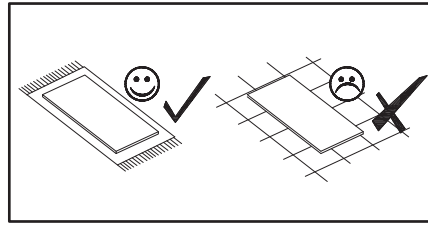

2

B11	
x4	Ø7x50

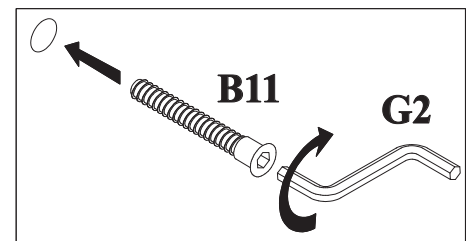
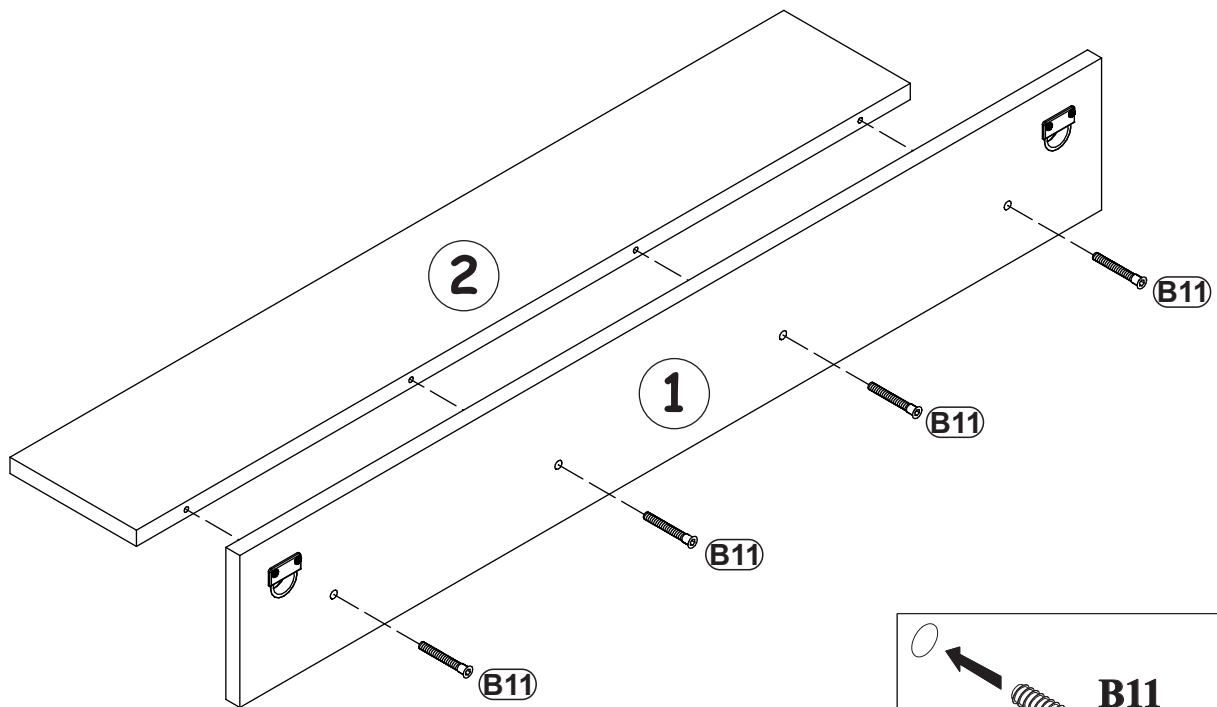

3

