

Denver

Шафа 3Д2Ш | Шкаф 3Д2Ш

Wardrobe 3D2S

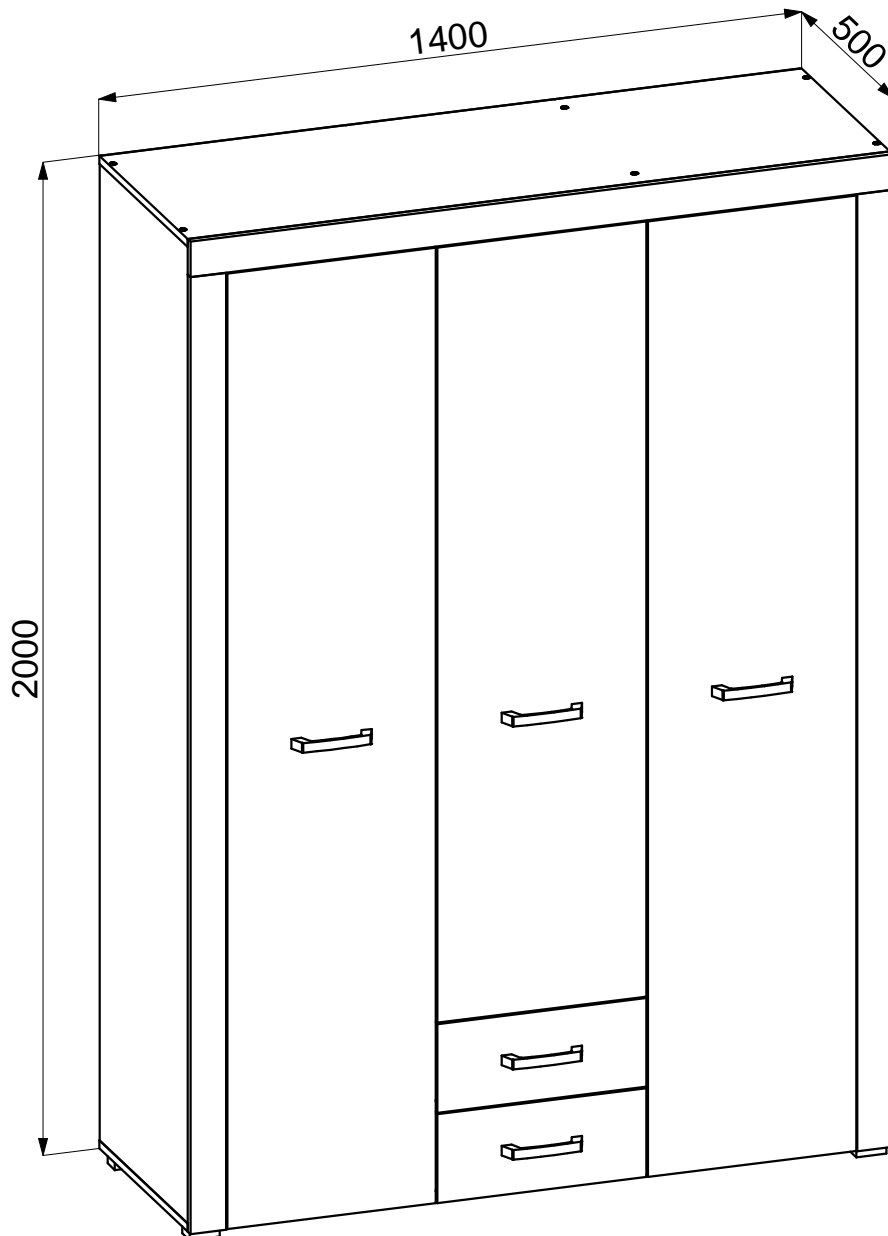





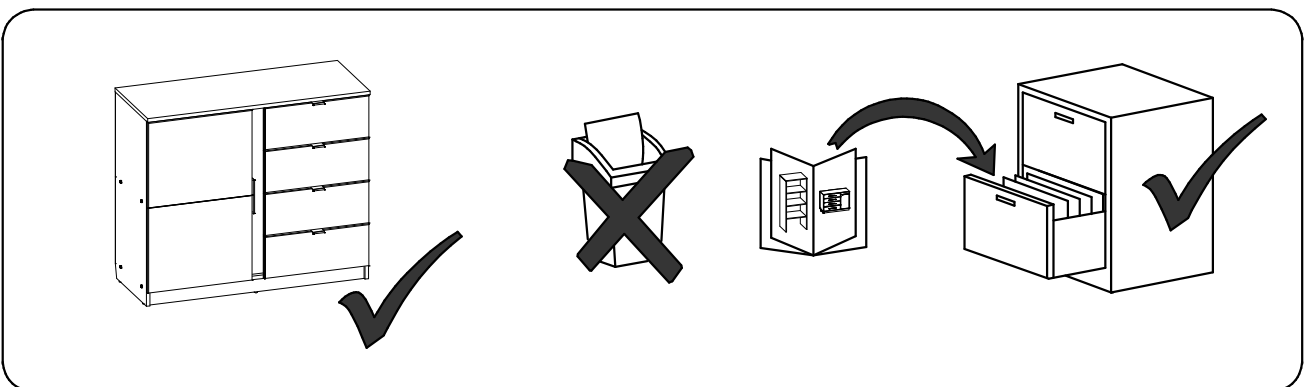
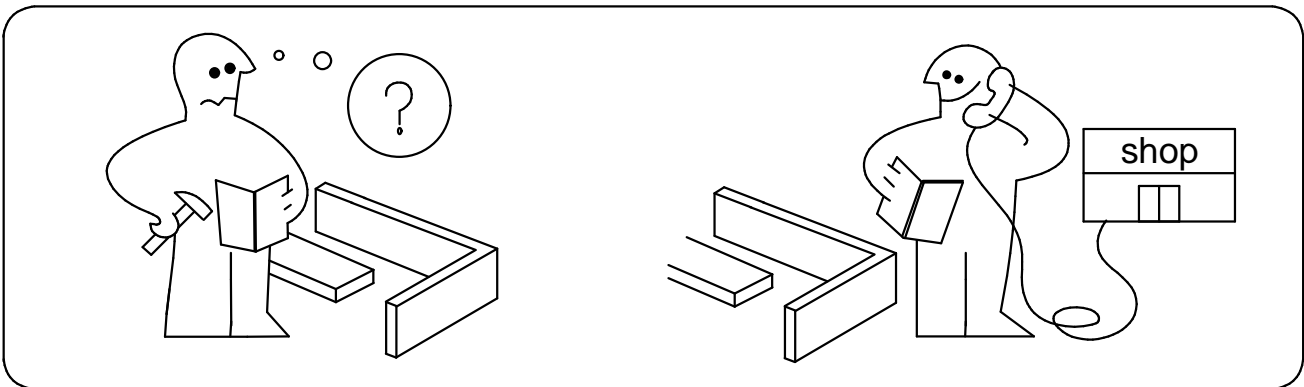
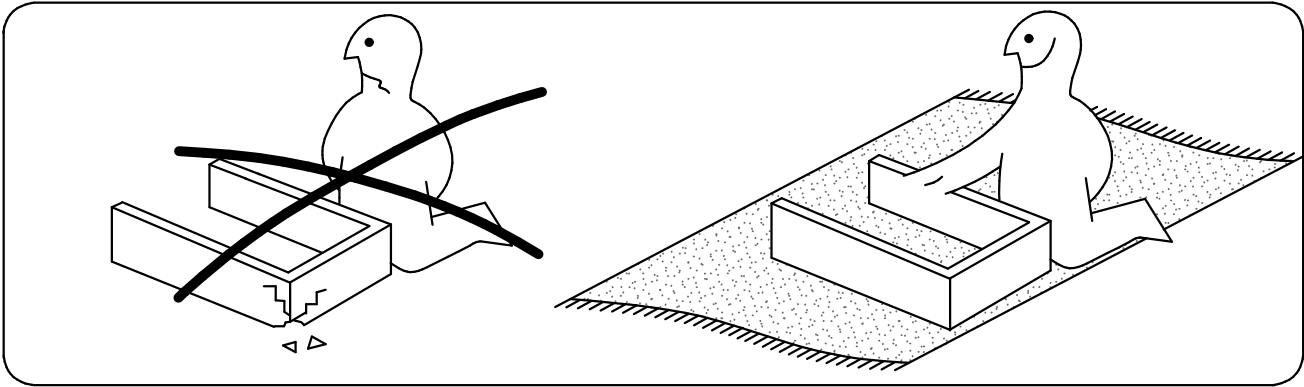
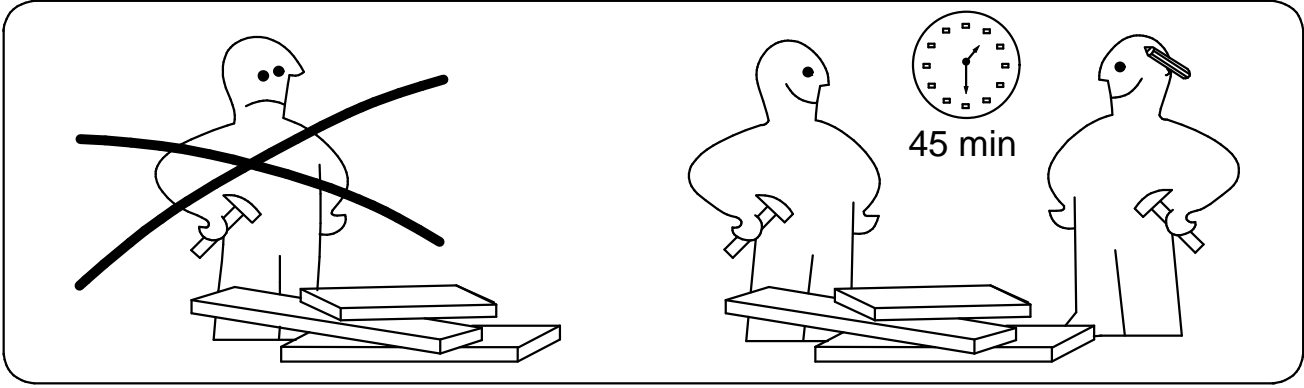
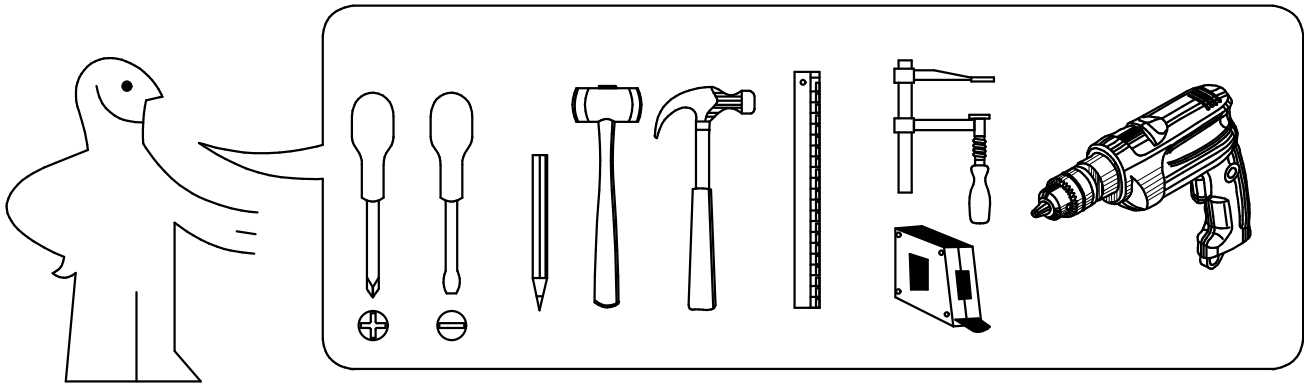

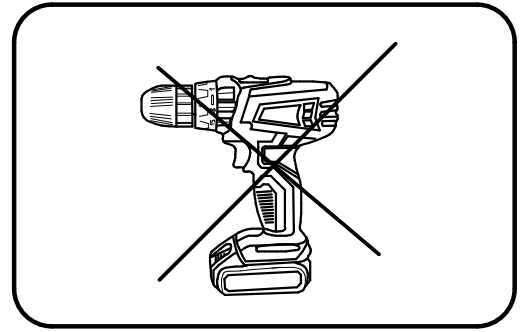
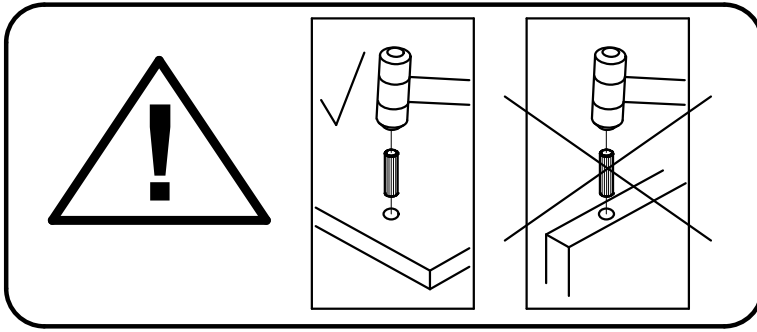



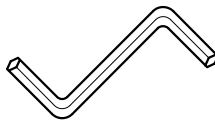
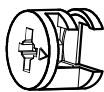
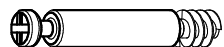

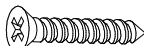

CMF Group
formula of style

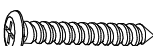
Модульна система | Модульная система | Modular system

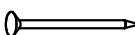

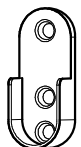
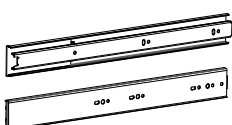
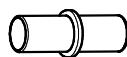
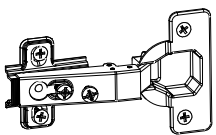
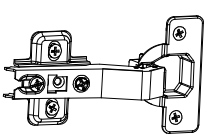
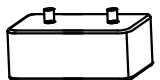
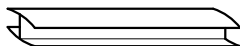
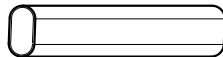

 Ø6,3x50 mm A1 x 31	 Ø12 mm A2 x 31	 4 mm A3 x 1	 Ø15x12 mm B1 x 25	 Ø5x44 mm B2 x 25
 Ø20 mm B3 x 25	 Ø12x3 mm C x 4	 Ø4x16 mm D1 x 72	 Ø4x20 mm D2 x 4	 Ø3x16 mm D3 x 4
 Ø4x30 mm D4 x 10	 Ø3x25 mm D5 x 18	 Ø1,6x25 mm F x 125	 Ø8x36 mm G x 33	 H x 5
 I x 2	 K x 2	 Ø5x16 mm L x 12	 M1 x 8	 M2 x 4
 N x 6	 O x 3	 P x 1	 Z x 18	

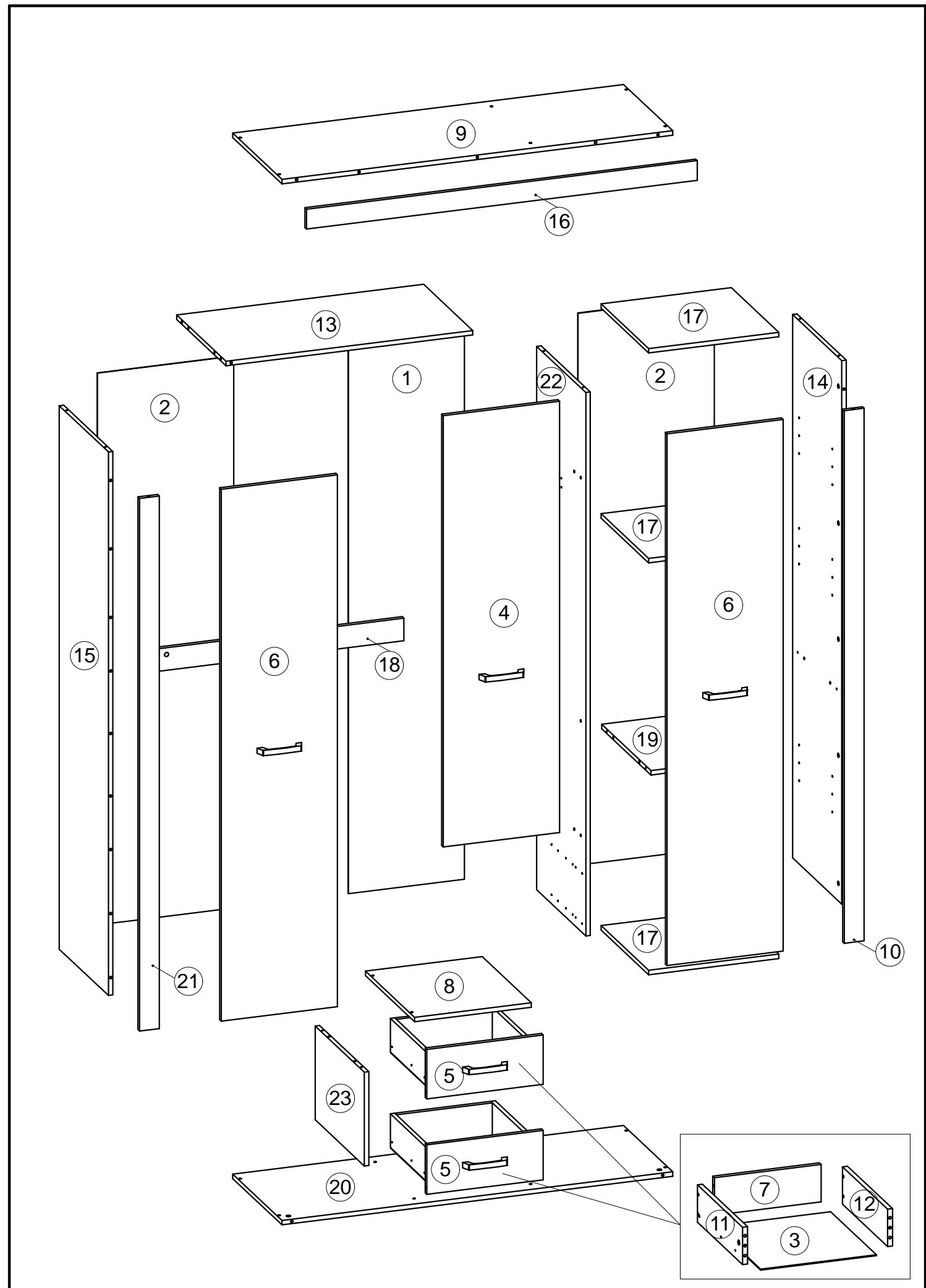

Box 1

484x418x16 mm

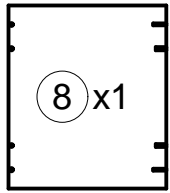

1400x484x16 mm

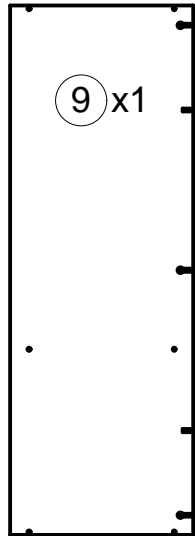

344x120x16 mm

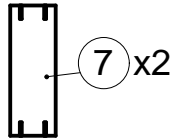

885x484x16 mm

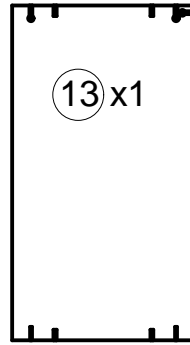

336x484x16 mm

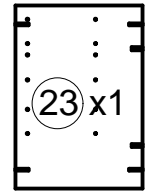

400x120x16 mm

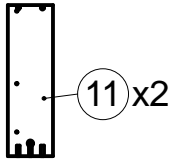

400x120x16 mm

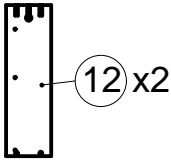

Fittings & Tools

Box

468x467x16 mm

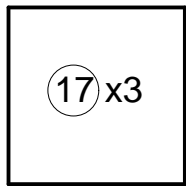

484x467x16 mm

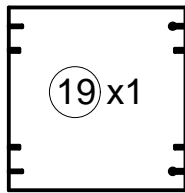

1400x484x16 mm

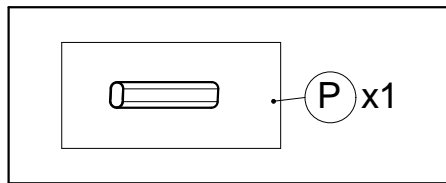
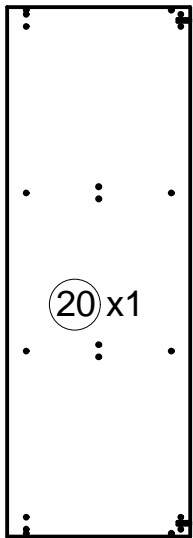

1545x416x16 mm

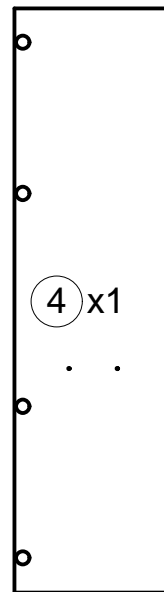

1905x415x16 mm

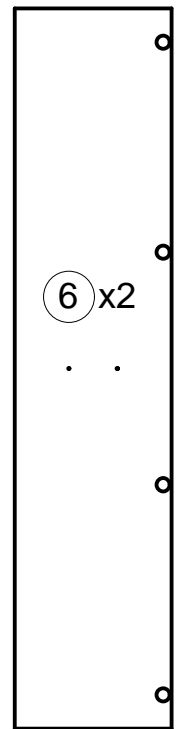

176x416x16 mm

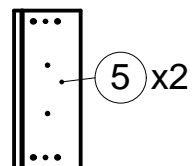

Box 2

1948x484x16 mm

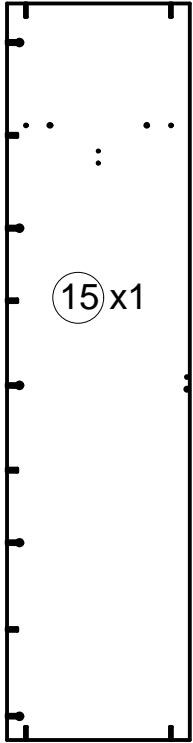

(15)x1

1400x70x16 mm



(16)x1

1908x70x16 mm



(21)x1

374x406x3 mm

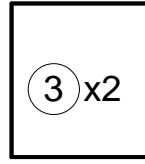

(3)x2

1948x484x16 mm

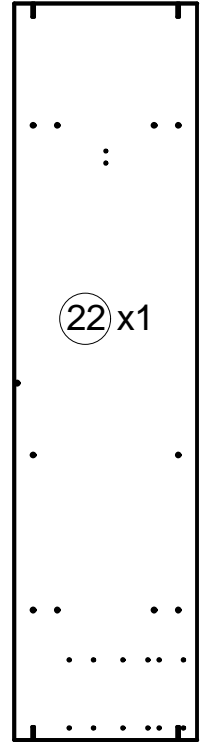

(22)x1

885x80x16 mm



(18)x1

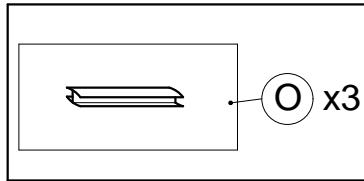

(O)x3

1948x484x16 mm

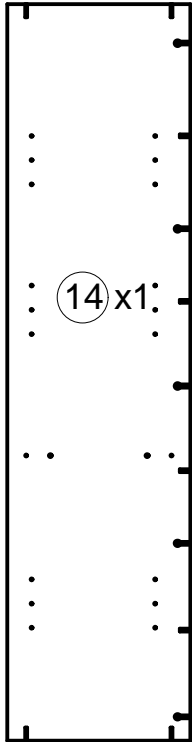

(14)x1

1978x416x3 mm

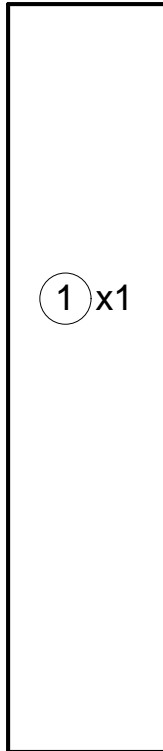

(1)x1

1978x489x3 mm

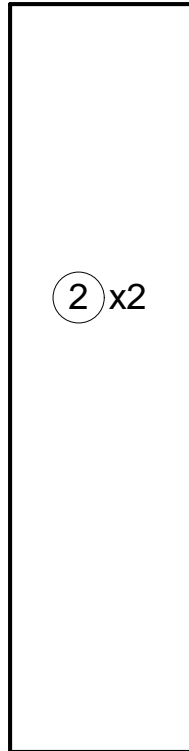

(2)x2

1908x70x16 mm



(10)x1

1

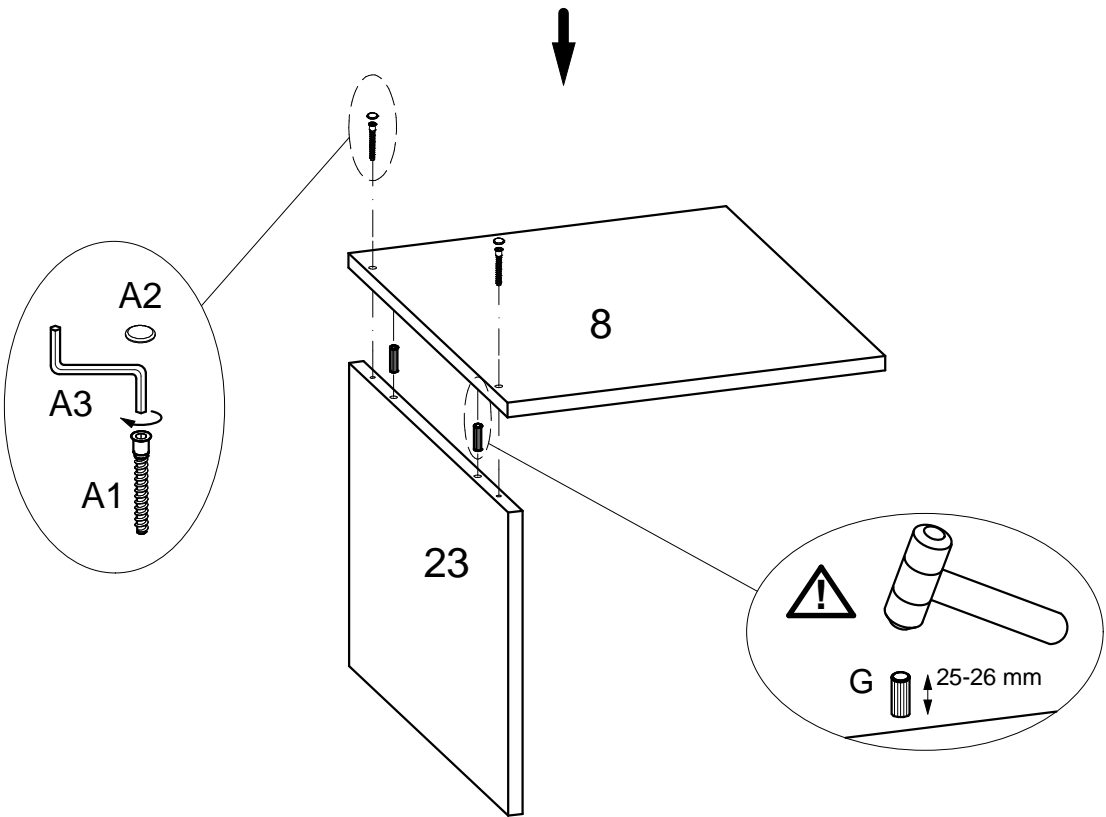
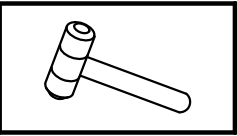
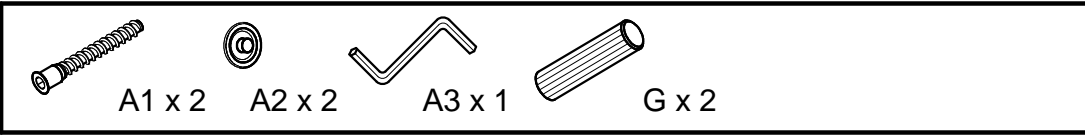

2

- A1 x 7
- A2 x 7
- A3 x 1
- B1 x 5
- B2 x 5
- B3 x 5
- D3 x 4
- G x 11

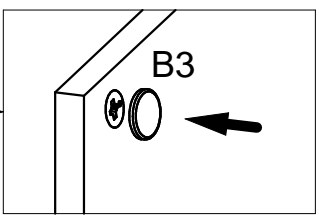
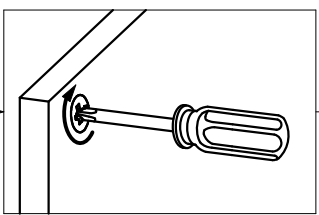
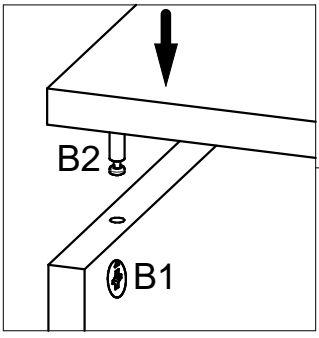
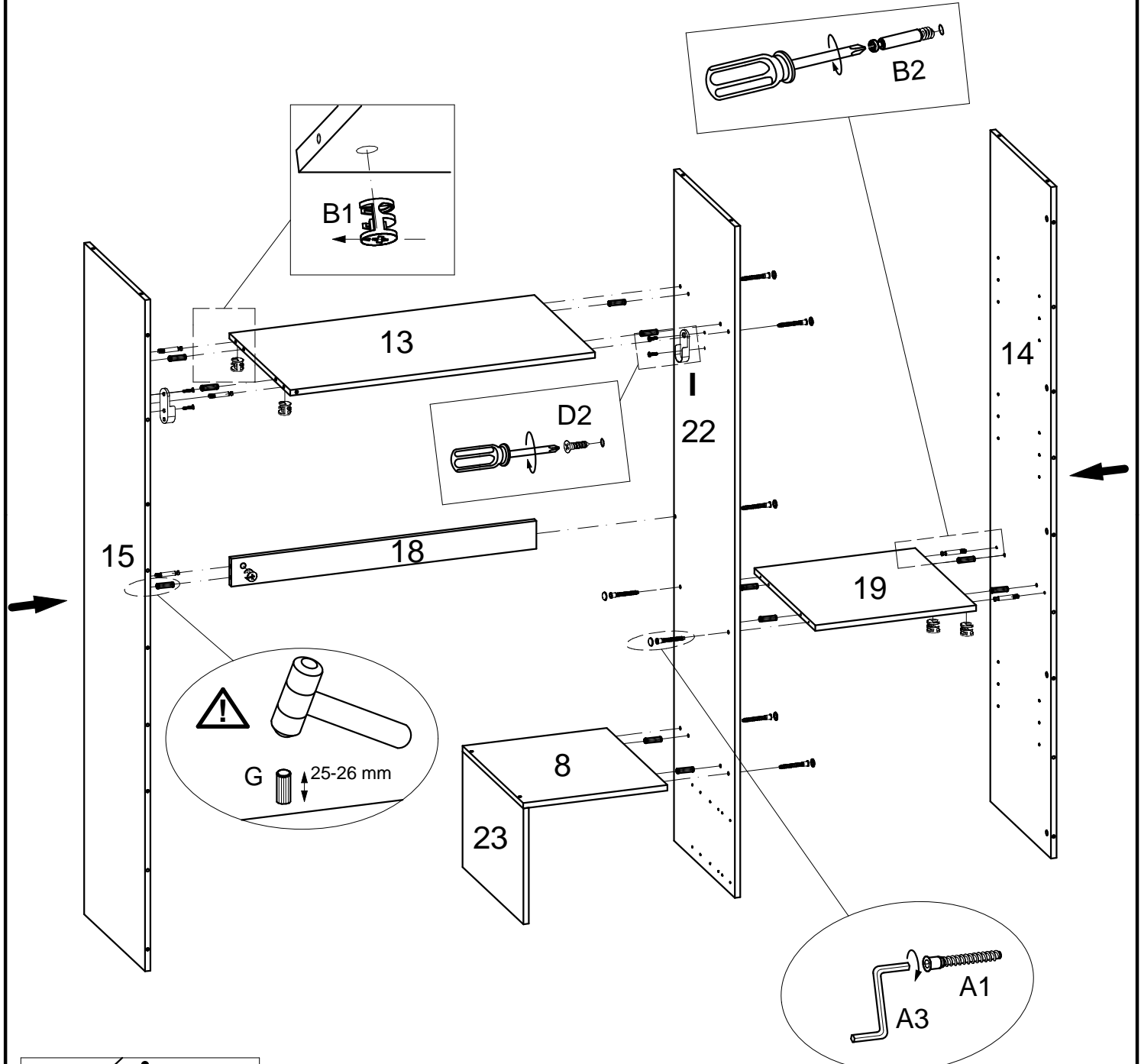
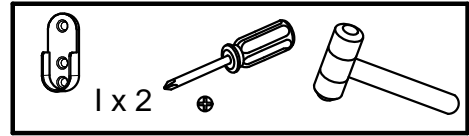

3

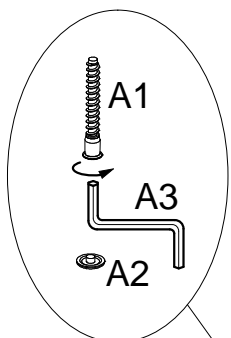
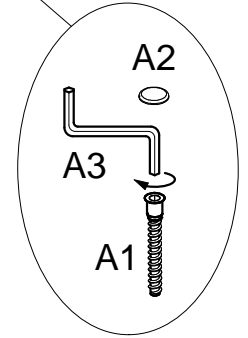
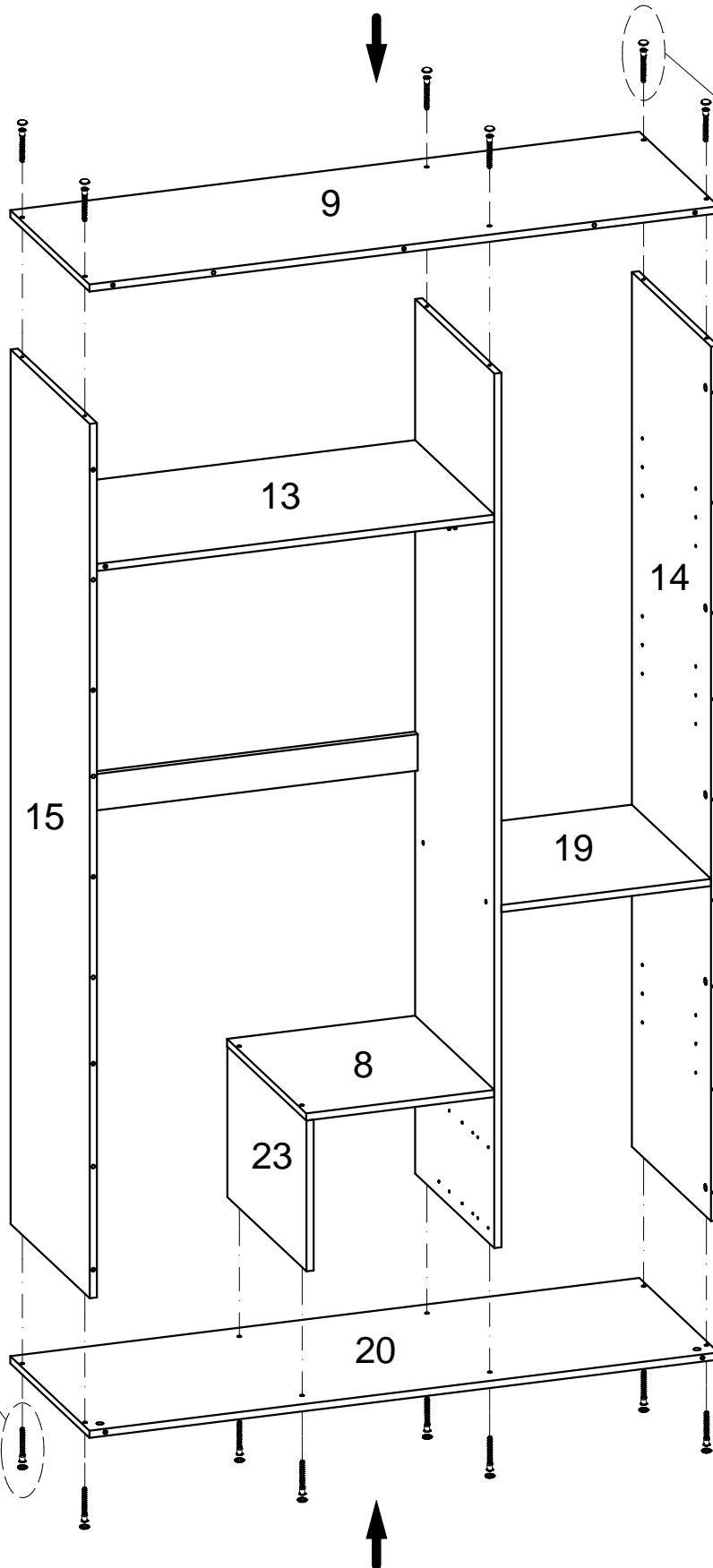
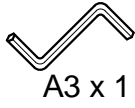
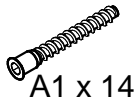

4



D1 x 16



M1.1 x 8

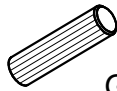

G x 2

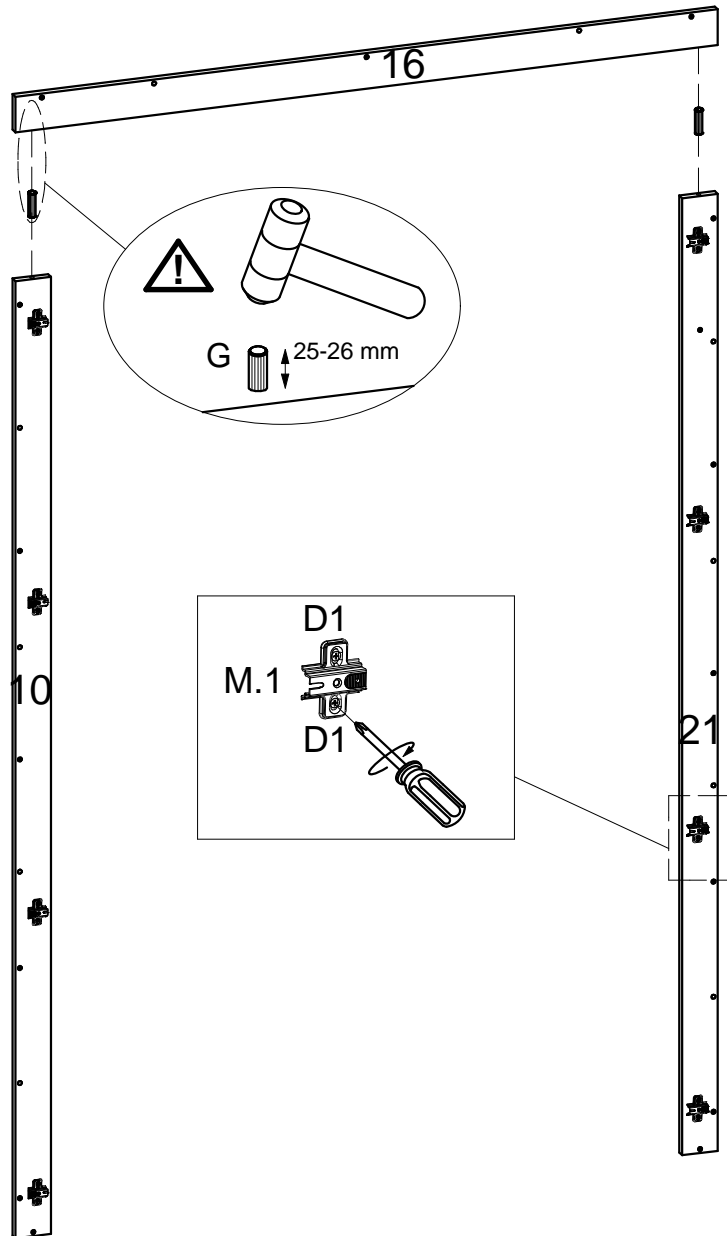
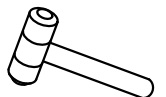
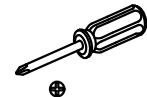

5



B1 x 16

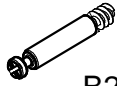

B2 x 16



B3 x 16

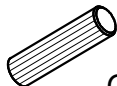

G x 10

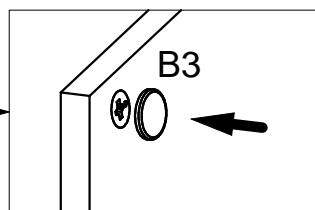
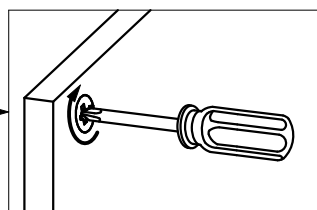
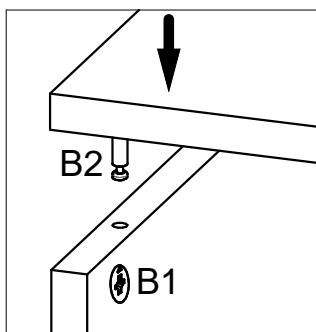
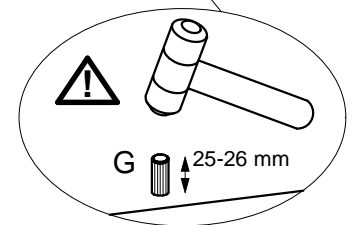
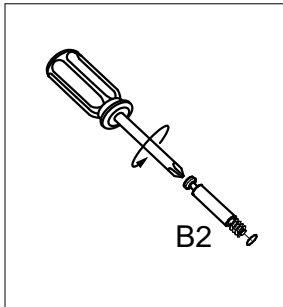
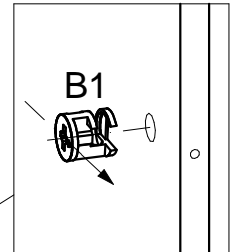
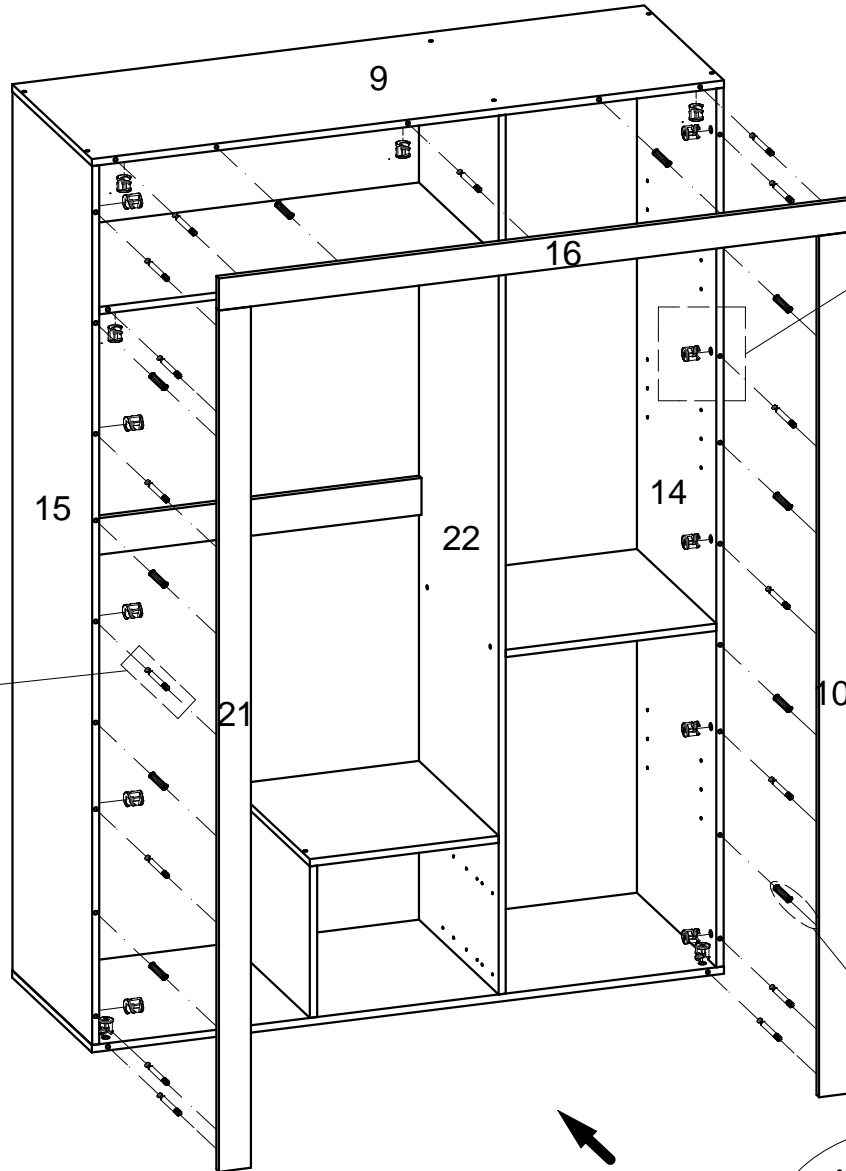
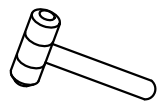
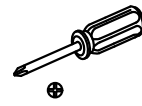

6



C x 4



D2 x 4



D5 x 18

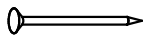

F x 81

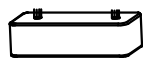

N x 6

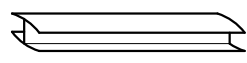

O x 2



Z x 18

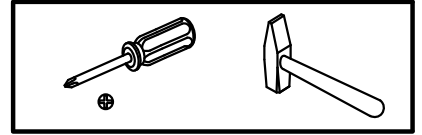

⚠ XX=YY≅90°

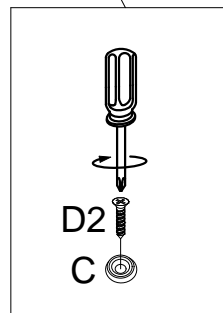
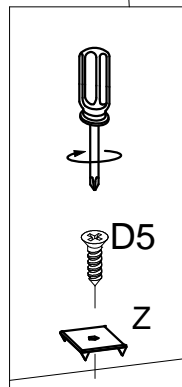
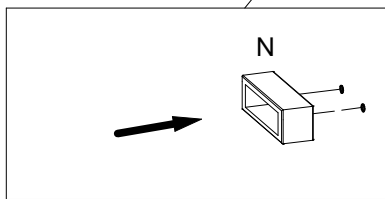
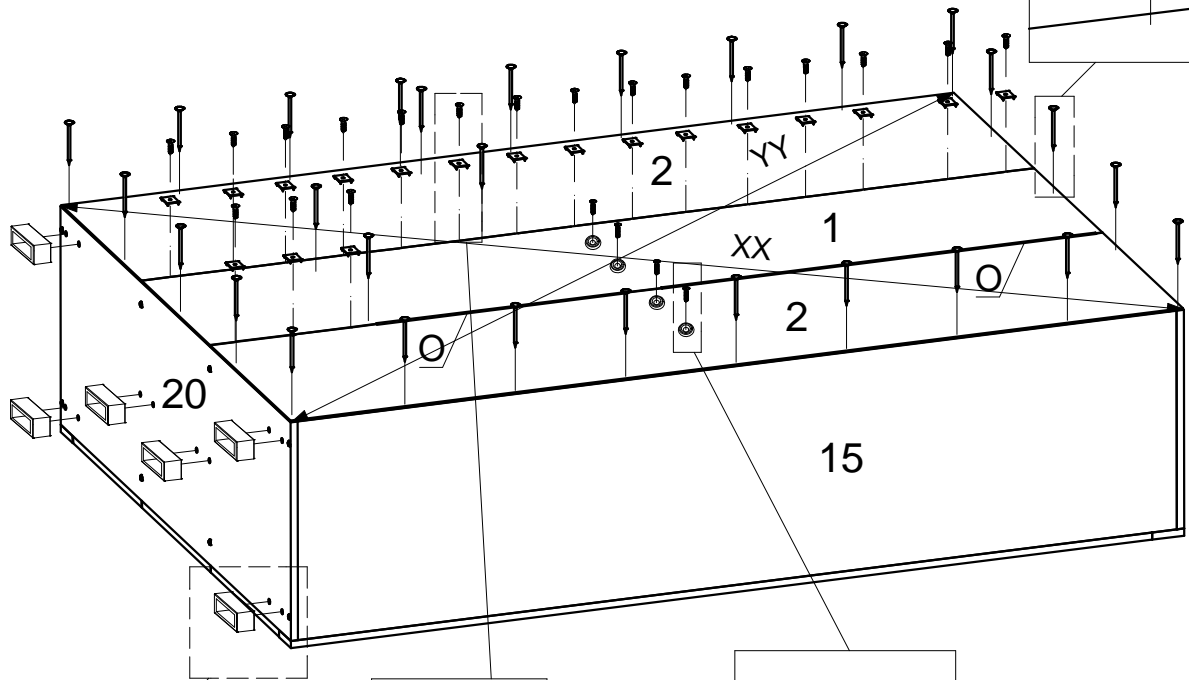
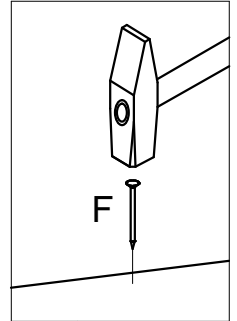

7

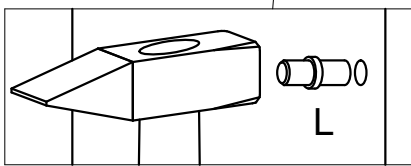
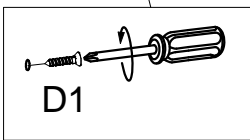
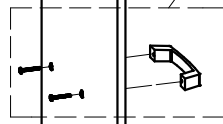
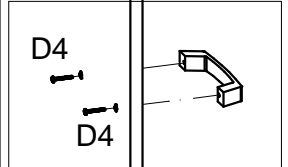
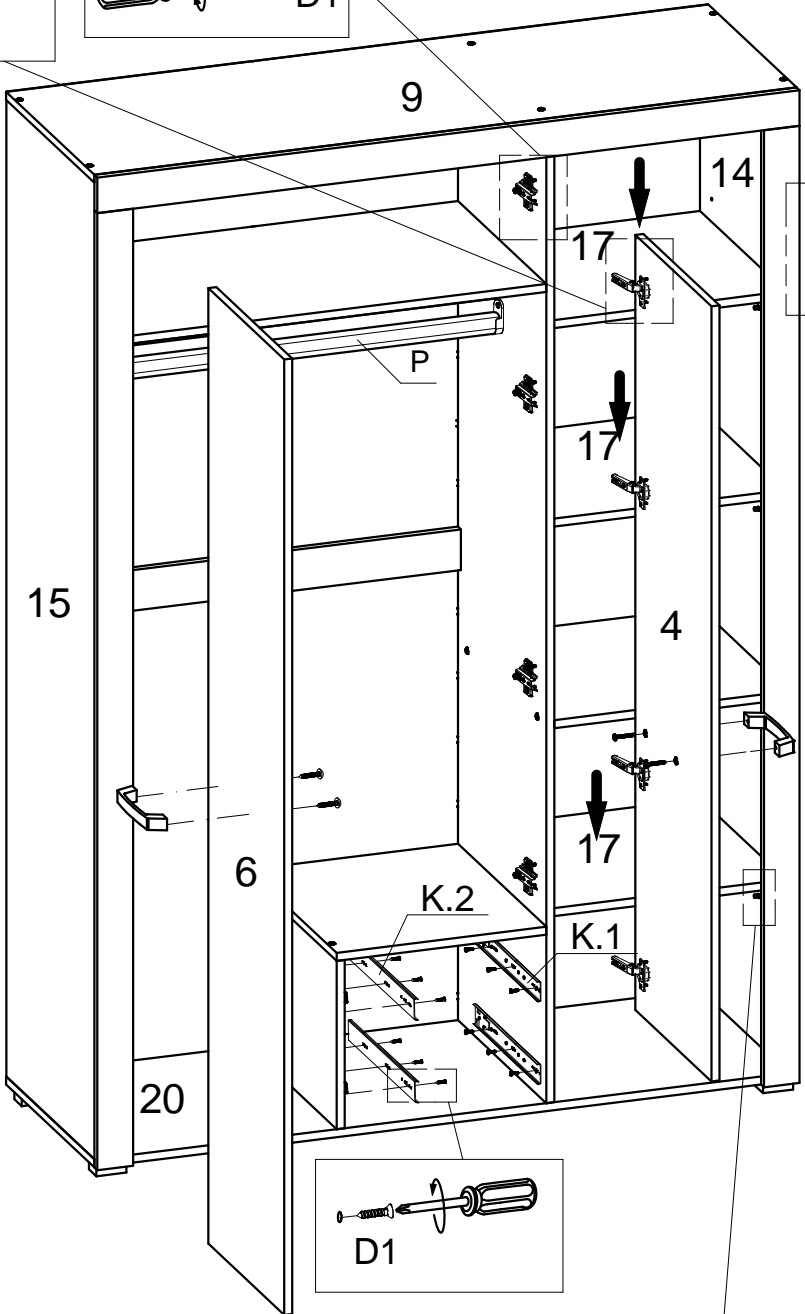
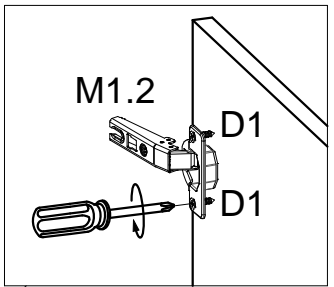
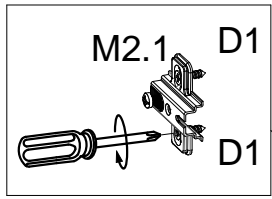
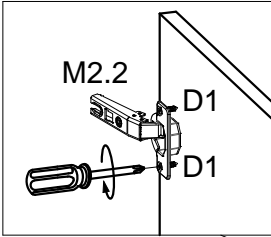
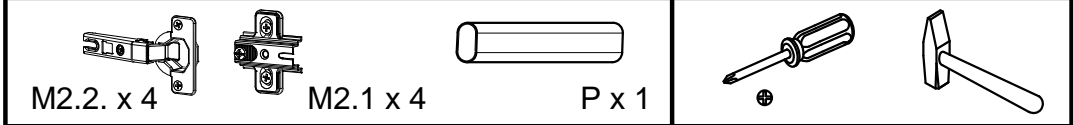
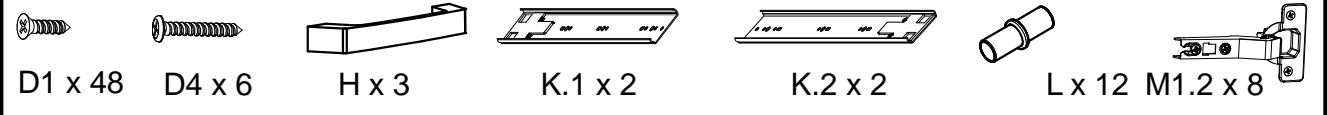

8

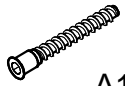

A1 x 8



A2 x 8



A3 x 1



B1 x 4

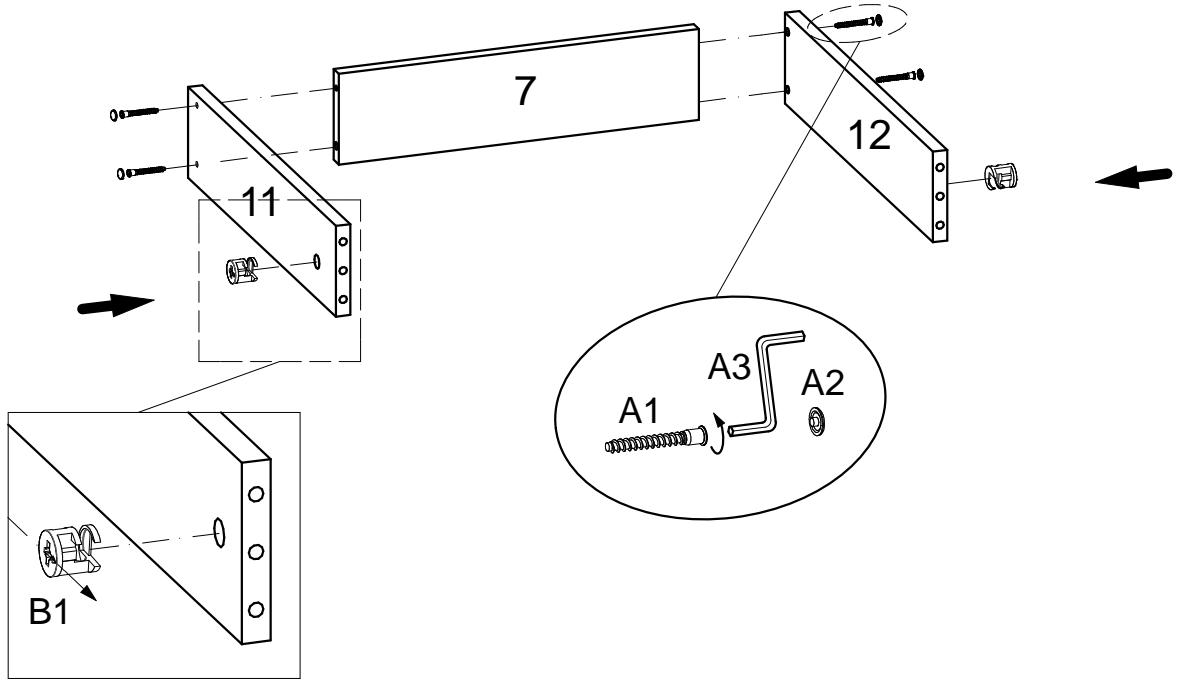

x 2

9

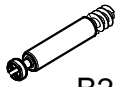

B2 x 4



B3 x 4



D4 x 4



H x 2

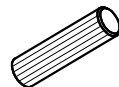

G x 8

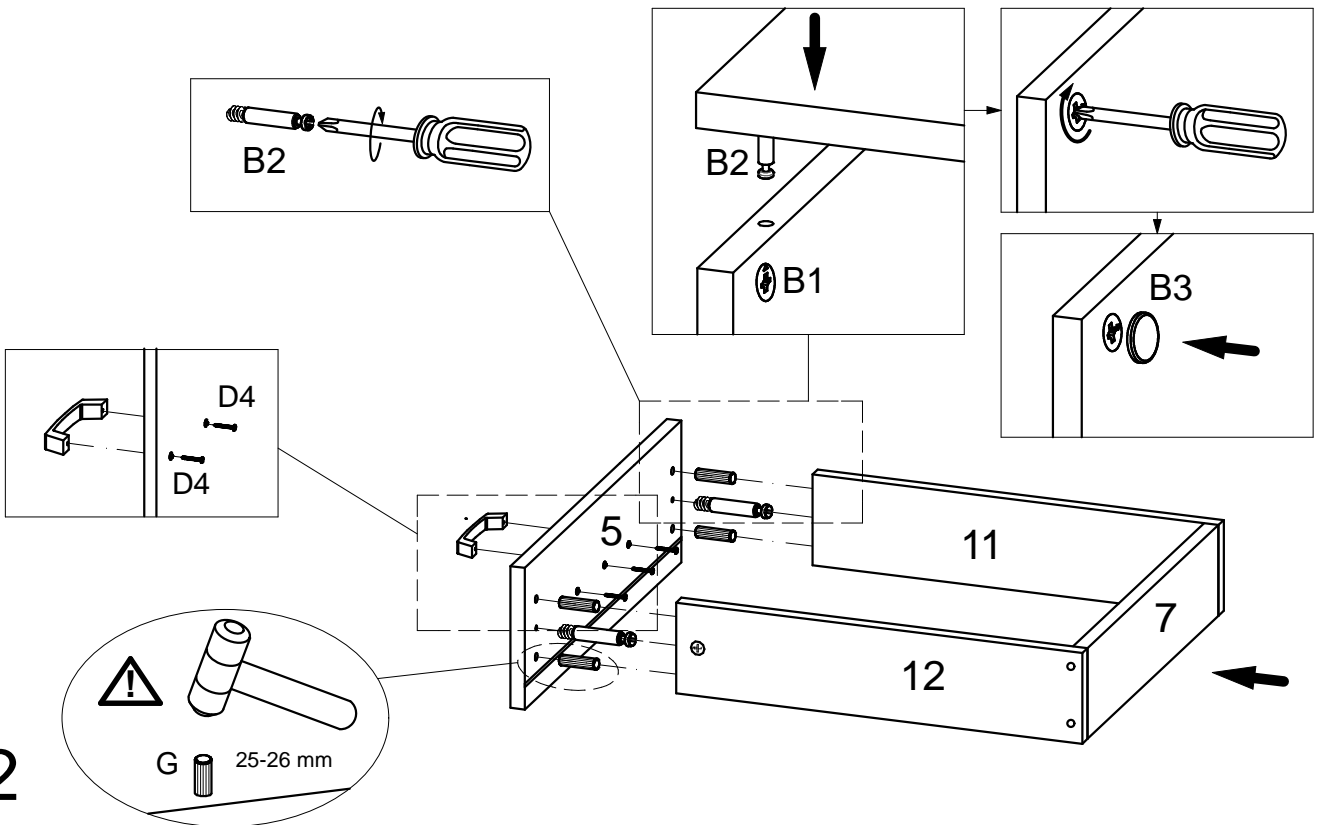
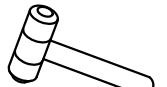
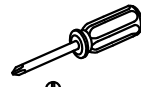

x 2

10

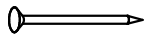

F x 44

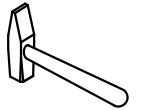

⚠ XX=YY≅90°

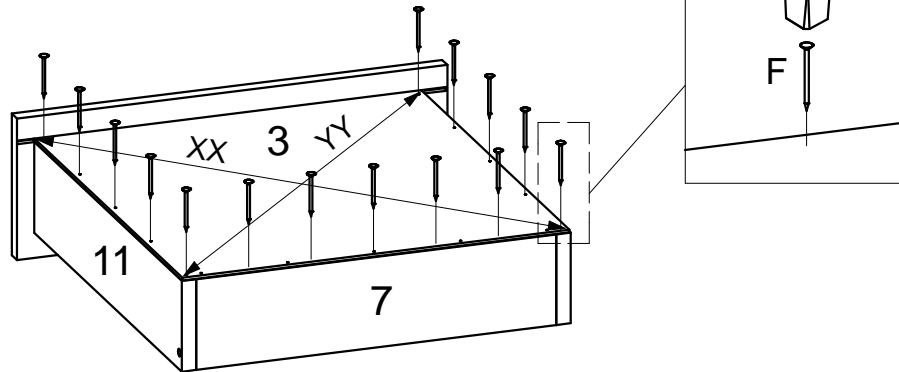

x 2

11



D1 x 24



K.3 x 4



K.4 x 4

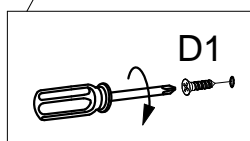
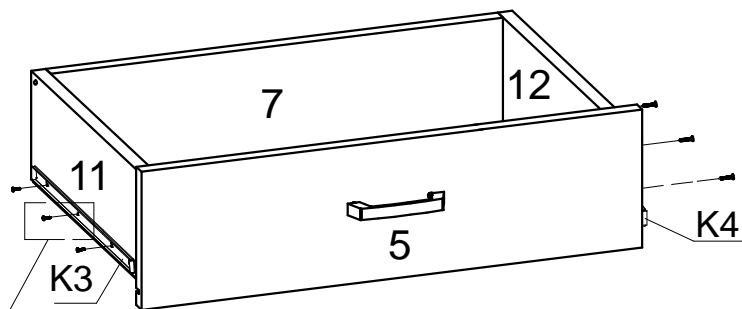
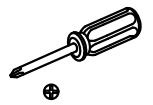

x 2

