

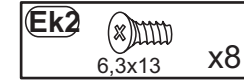

Typ:L Typ:P

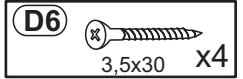
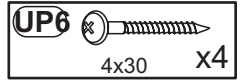
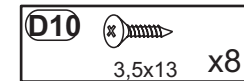
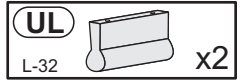
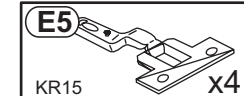
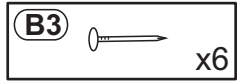
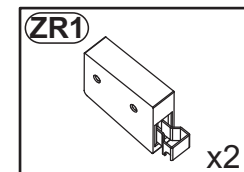
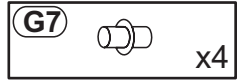
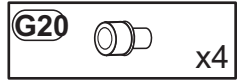
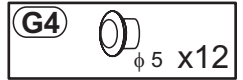
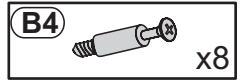
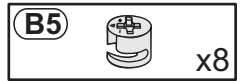
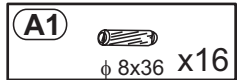
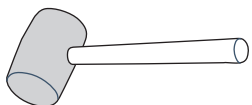
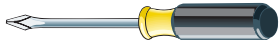
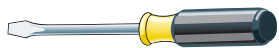
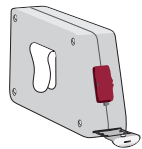
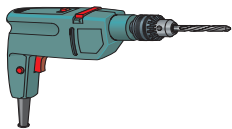
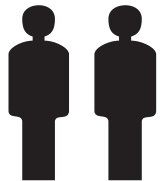
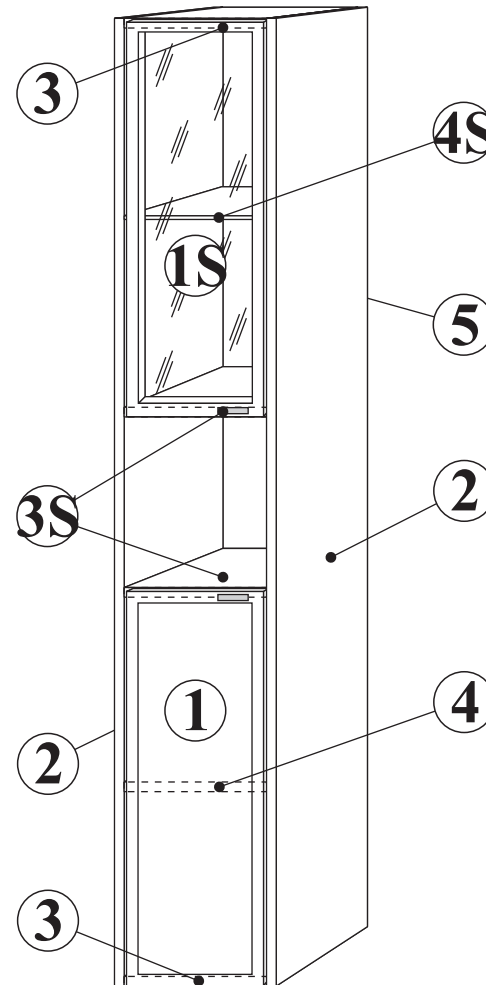
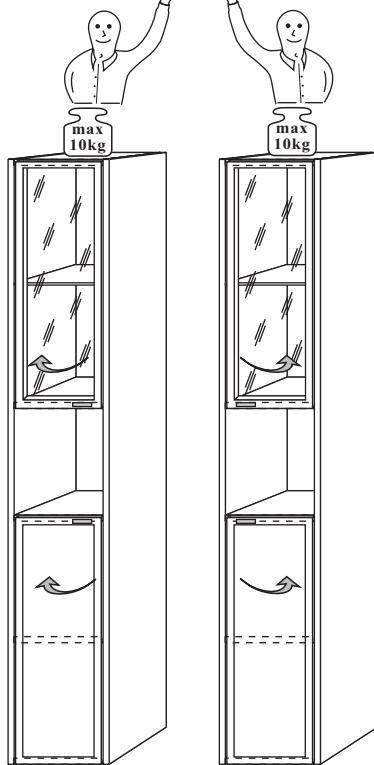

Osoba, která provádí uchycení visících skříněk na stěnu, je za tuto montáž zodpovědná ! Na montáž musí být použity vhodné šrouby a hmoždinky podle tytu stěny (sádkarton, cihla, panel, dřevo). Montážní díly nakupujte ve specializovaných obchodem po poradě s odborným personálem.

1

Typ:L

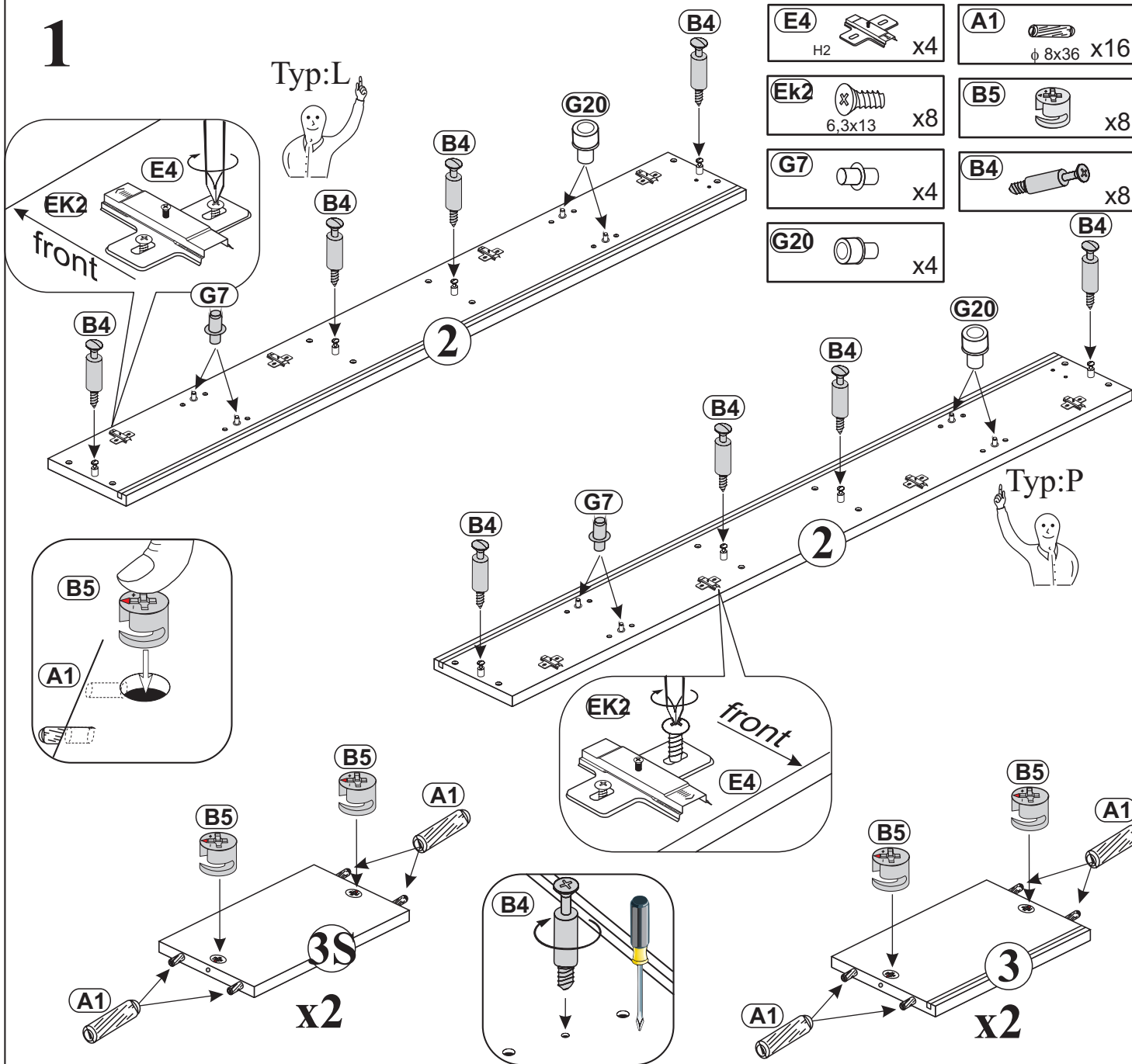

2

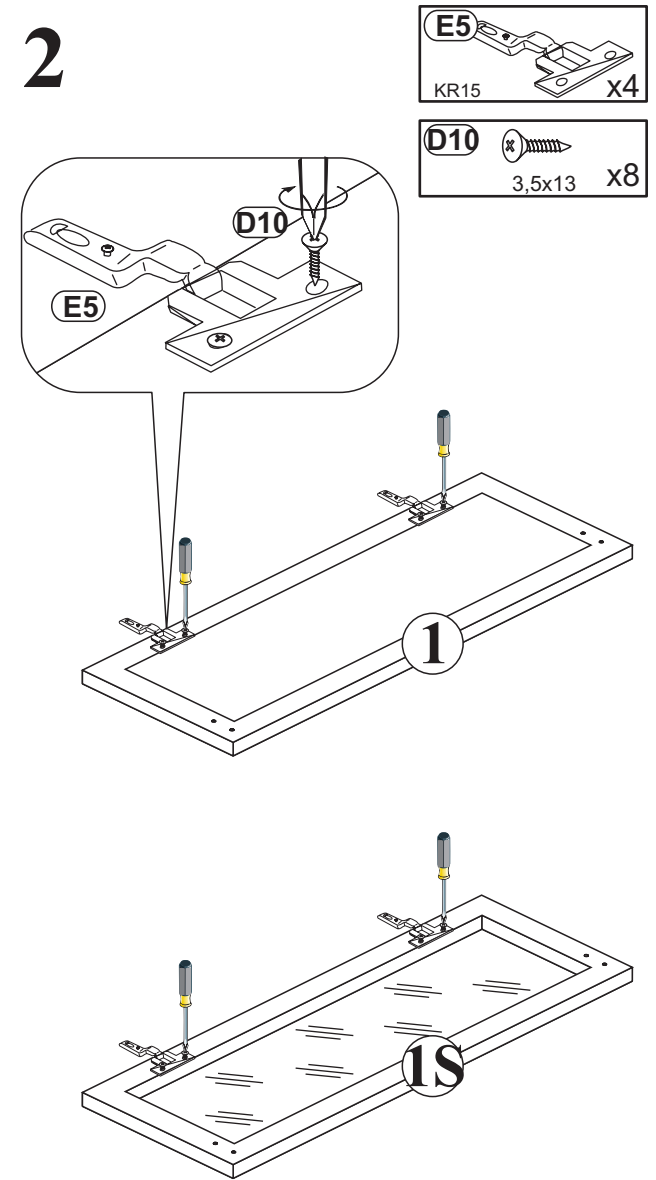

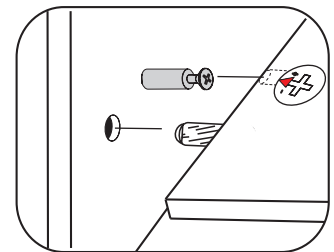
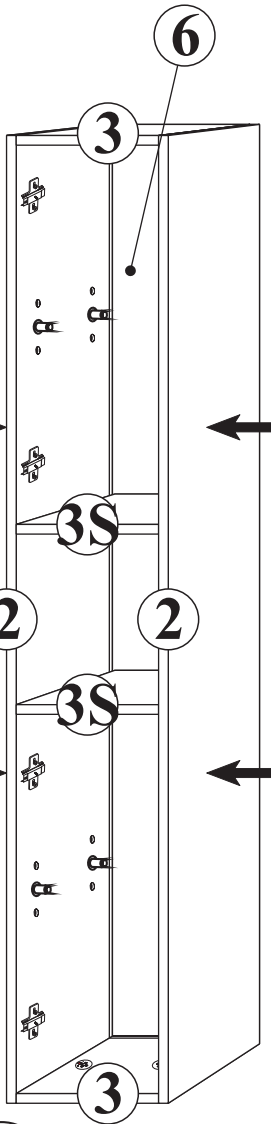

3 Typ:L

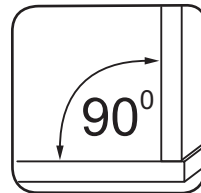
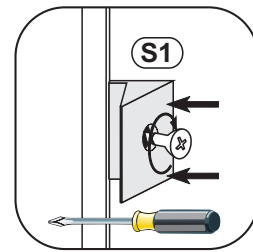
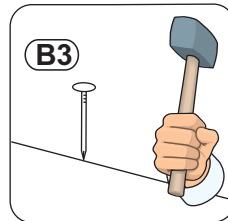
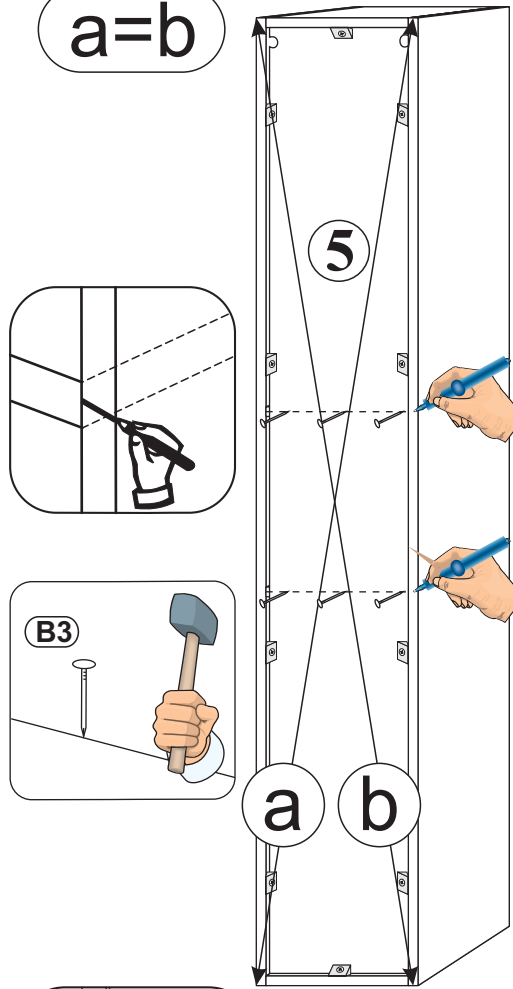

4 **B3** x6 **S1** x10

a=b



5 Typ:L

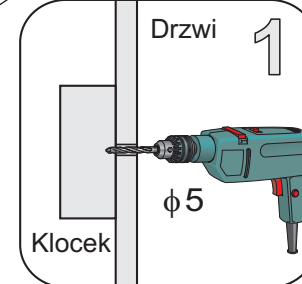
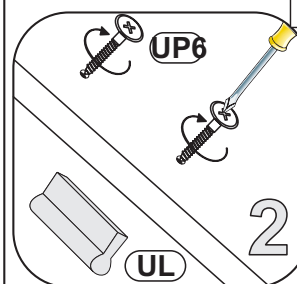
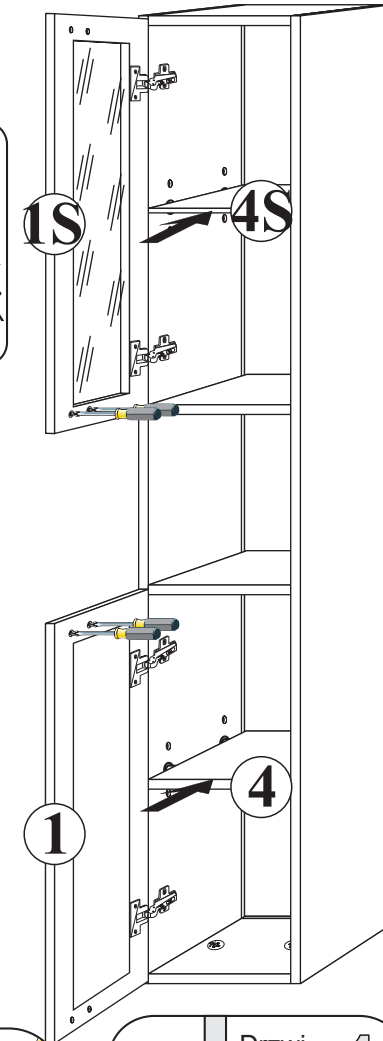
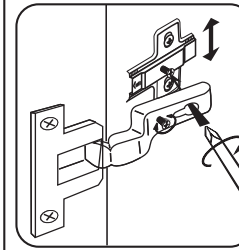

D6 3,5x30 x4

UL L-32 x2

UP6 4x30 x4

ZR1 x2

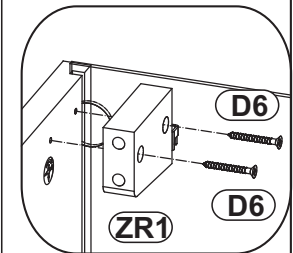

6

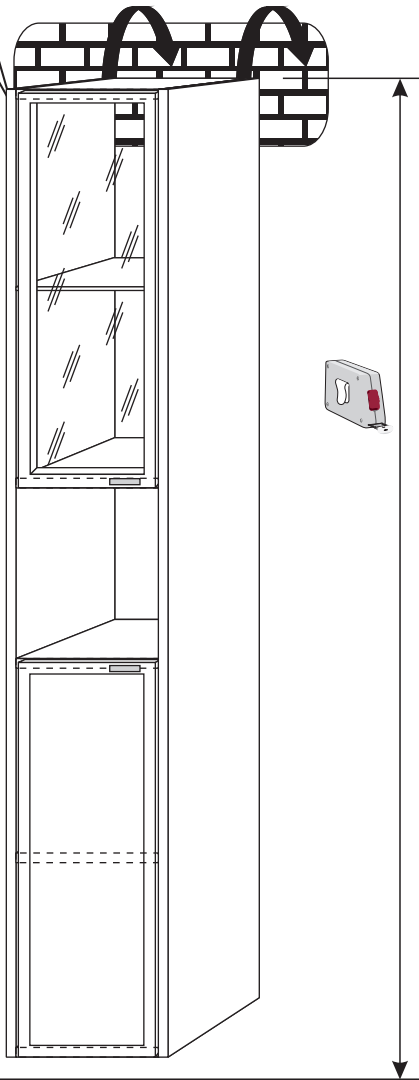
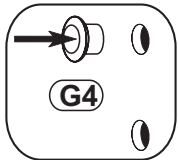
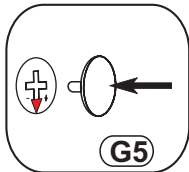
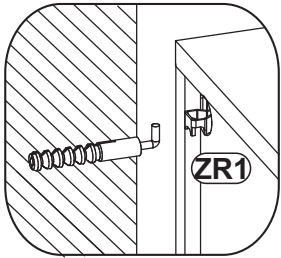
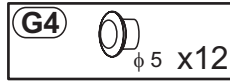
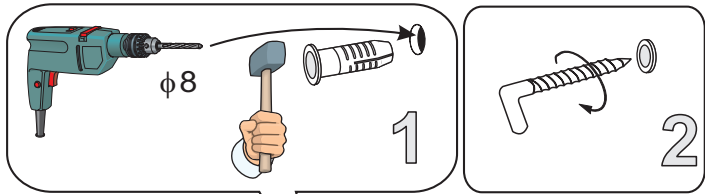

Osoba, která provádí uchycení visících skříněk na stěnu, je za tuto montáž zodpovědná! Na montáž musí být použity vhodné šrouby a hmoždinky podle typu stěny (sádrokarton, cihla, panel, dřevo ...). Montážní díly nakupujte ve specializovaných obchodech po poradě s odborným personálem.

Verstellmöglichkeiten

- a) Fugenverstellung:
Befestigungsschraube "A" lockern, gewünschte Fuge mit Schraube "B" einstellen, Schraube "A" anziehen.
- b) Tiefenverstellung:
Befestigungsschraube "A" lockern, Bandarm nach vorne oder rückwärts verschieben, Schraube "A" anziehen, Schraube "B" mit einer 1/4 Drehung nach rechts arretieren.
- c) Höhenverstellung:
Befestigungsschraube "C" lockern, Höhe einstellen, Schraube "C" anziehen.

Instructions for hinge adjustment

- a) Side adjustment:
Loosen fixing screw "A", adjust gap with screw "B" and retighten screw "A".
- b) Depth adjustment:
Loosen fixing screw "A", push hinge arm forwards or backwards, retighten screw "A", fix screw "B" with a 1/4-turn in clock-wise direction.
- c) Height adjustment:
Loosen screw "C", adjust height, retighten screw "C".

Les possibilités de positionnement

- a) Positionnement de la rainure:
Desserrer la vis de fixation "A", positionner avec la vis "B" la rainure (joint) souhaitée et resserrer la vis "A".
- b) Positionnement de la profondeur:
Desserrer la vis de fixation "A" (1 tour), régler la profondeur et resserrer la vis "A".
- c) Positionnement de la hauteur:
Desserrer la vis de fixation "C" (1 tour), positionner la hauteur et resserrer la vis "C".

Możliwości regulacji

- a) Regulacja szczeliny:
Poluzować wkręt "A", wkrętem "B" ustawić odpowiednią szczelinę, dokręcić wkręt "A".
- b) Regulacja głębokości:
Poluzować wkręt "A" (1 obrót), ustawić głębokość, dokręcić wkręt "A".
- c) Regulacja wysokości:
Poluzować wkręt "C" (1 obrót), dokonać regulacji wysokości położenia drzwi, wkręt "C" dokręcić.

