























- A1**   $\phi$  8x36 x16
- B5**  x16
- B4**  x16
- G5**  #15 x16
- G4**   $\phi$  5 x12
- E1**  Kr0 x4
- G7**  x12
- D10**  3,5x13 x10
- E2**  H0 x4
- I2**  x4
- Ek2**  6,3x13 x8
- B3**  x6
- L1**  x1
- UL**  L-32 x3
- KR2**  x1
- UP6**  4x30 x6
- D22**  4x40 x1
- G2**  S-4 x1

1

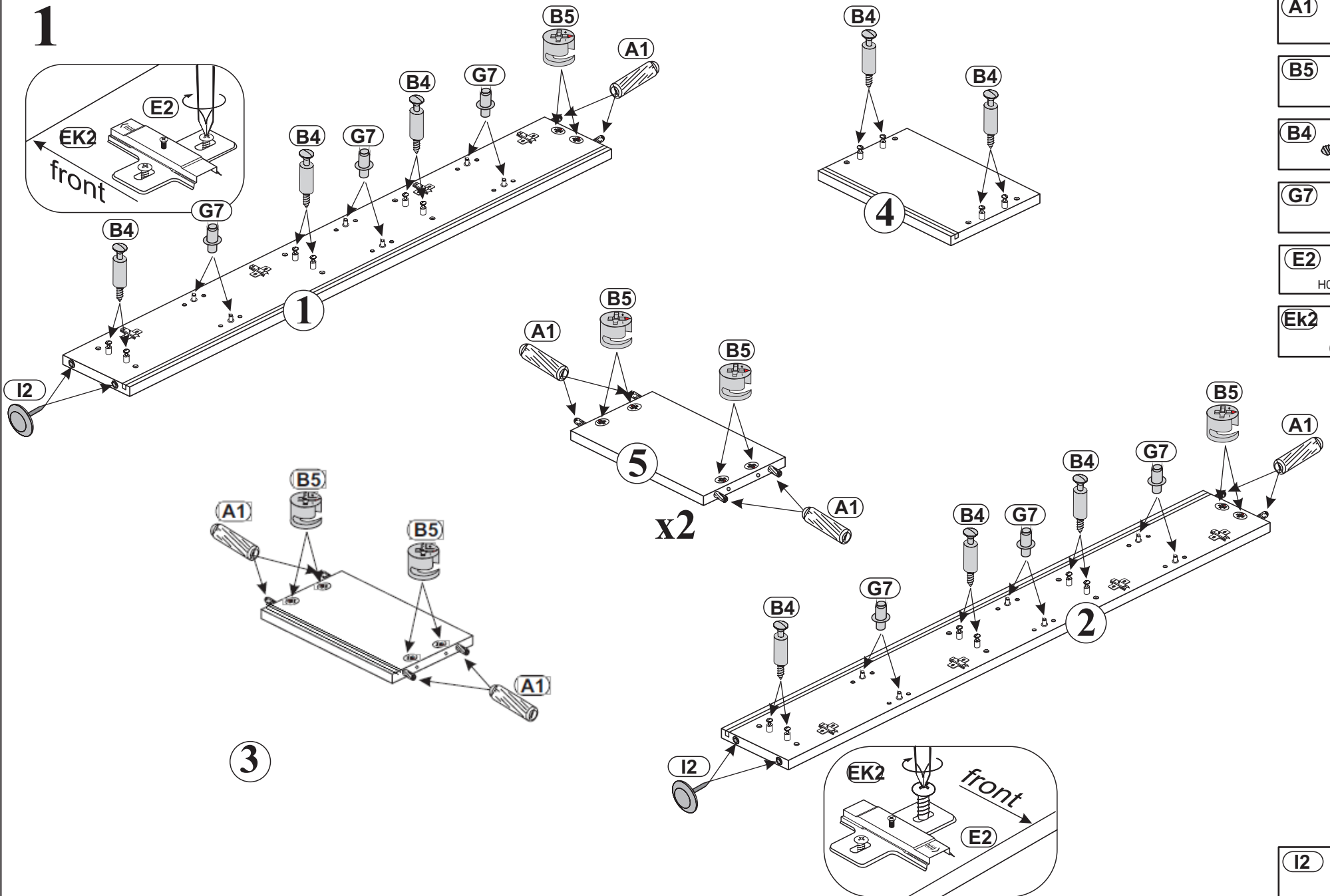



**A1**   $\phi$  8x36 x16

**B5**  x16

**B4**  x16

**G7**  x12

**E2**  H0 x4

**EK2**  6,3x13 x8

**I2**  x4

2

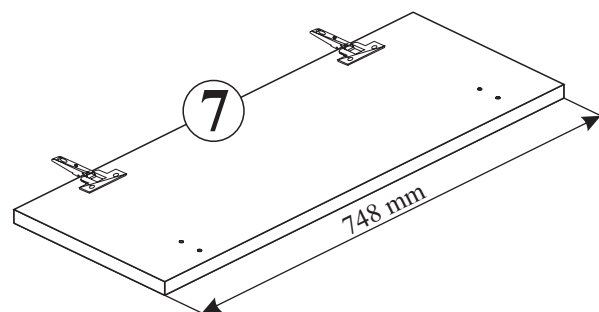
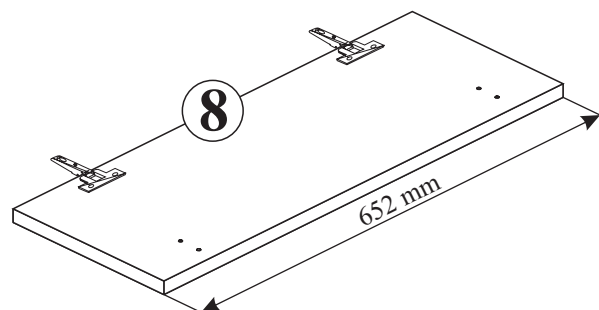
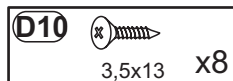
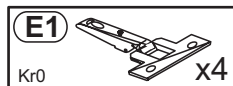
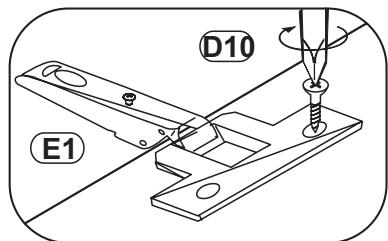

3

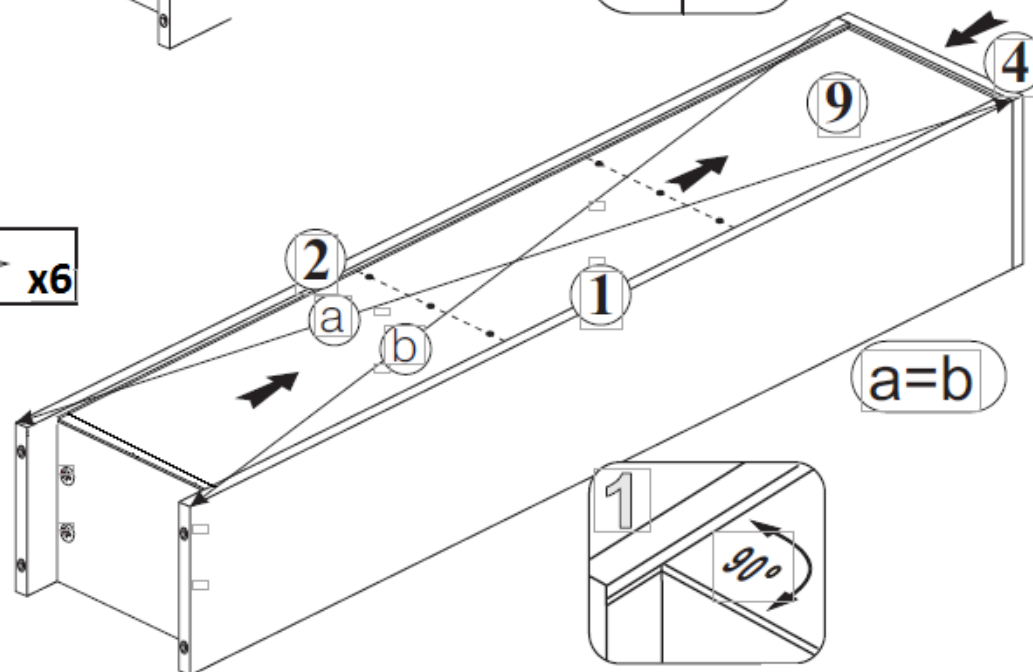
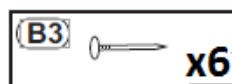
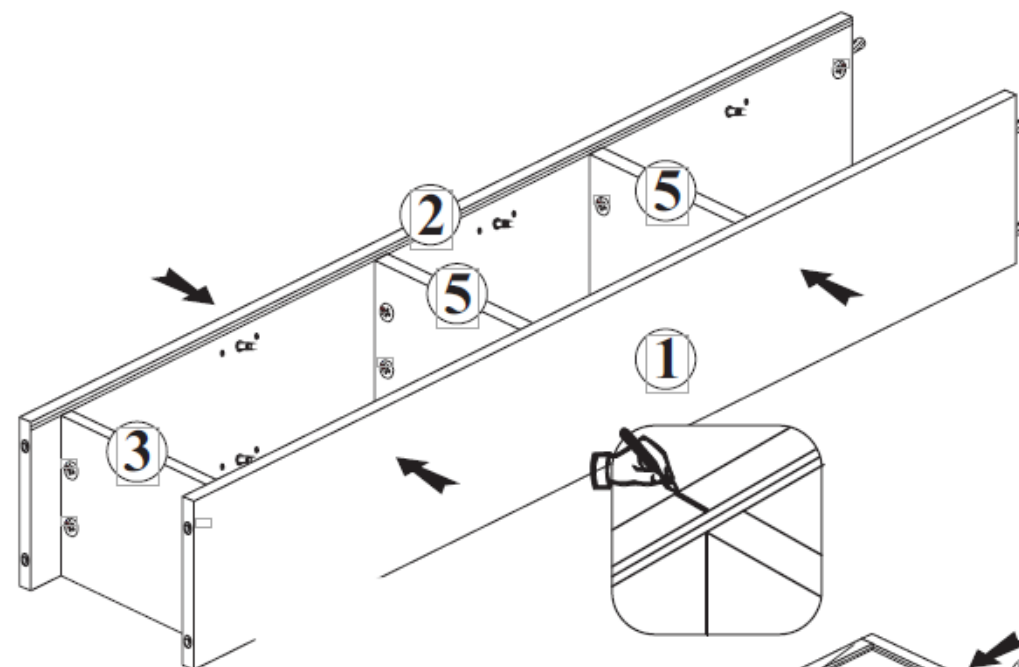

# PALERMO SL - 190

4/5

4

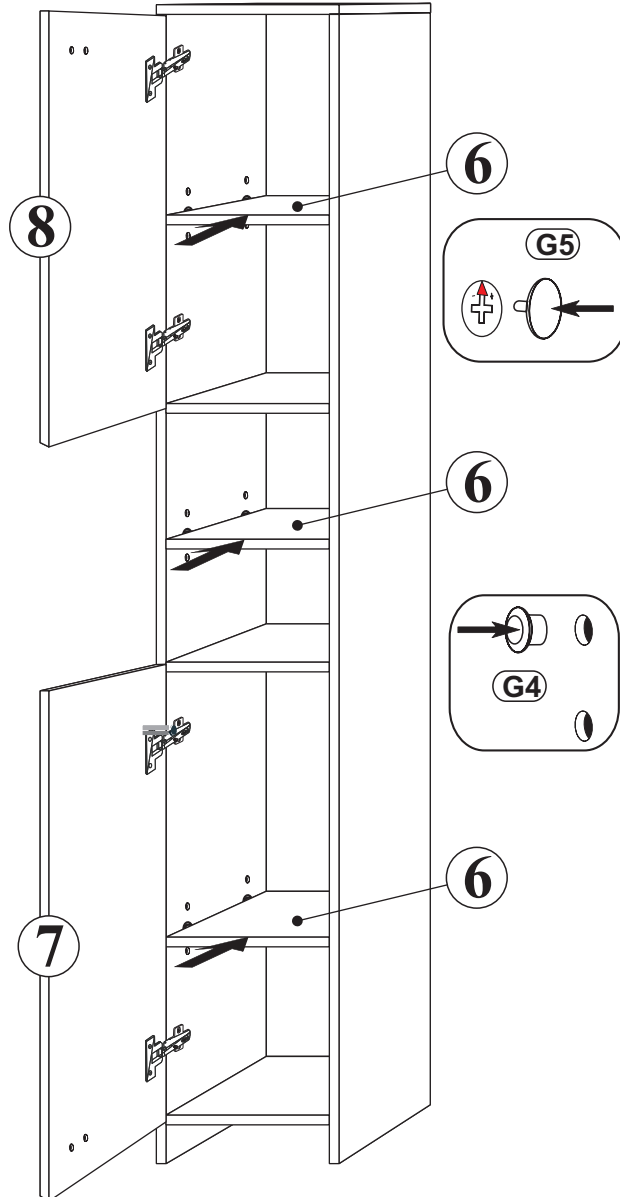
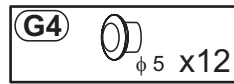
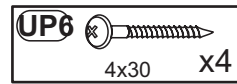
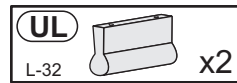
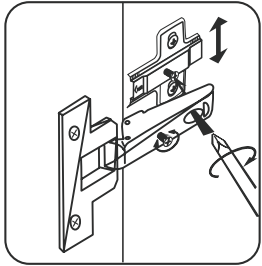

5

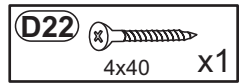
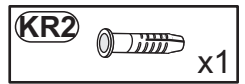
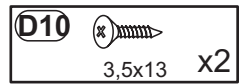
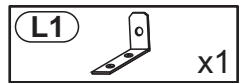
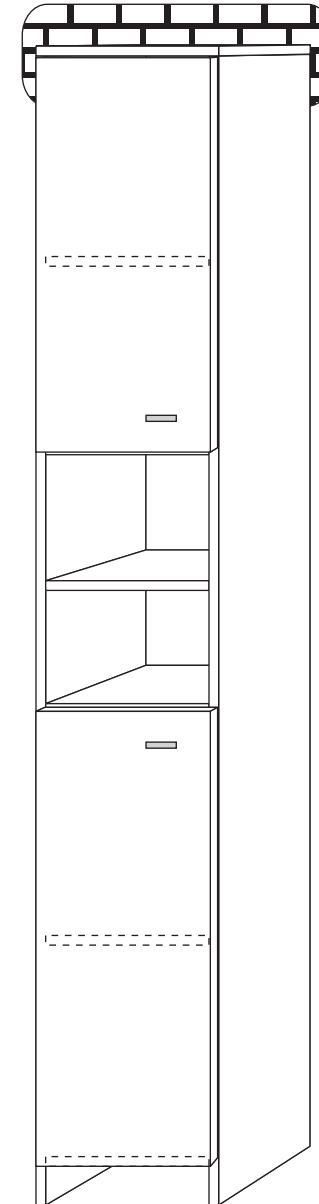
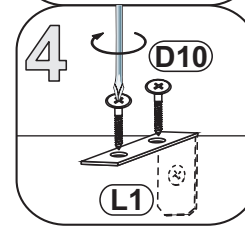
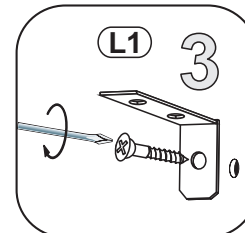

a)

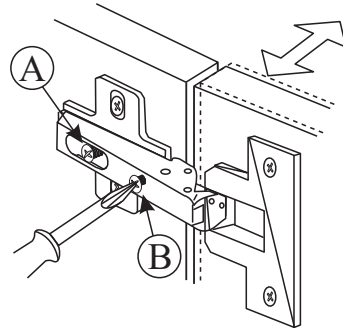

b)

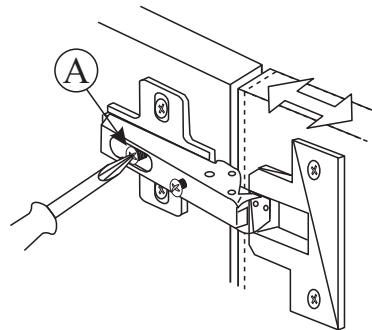

c)

