

# NESEBAR XL

BJ01

DL01

WH01

SO01

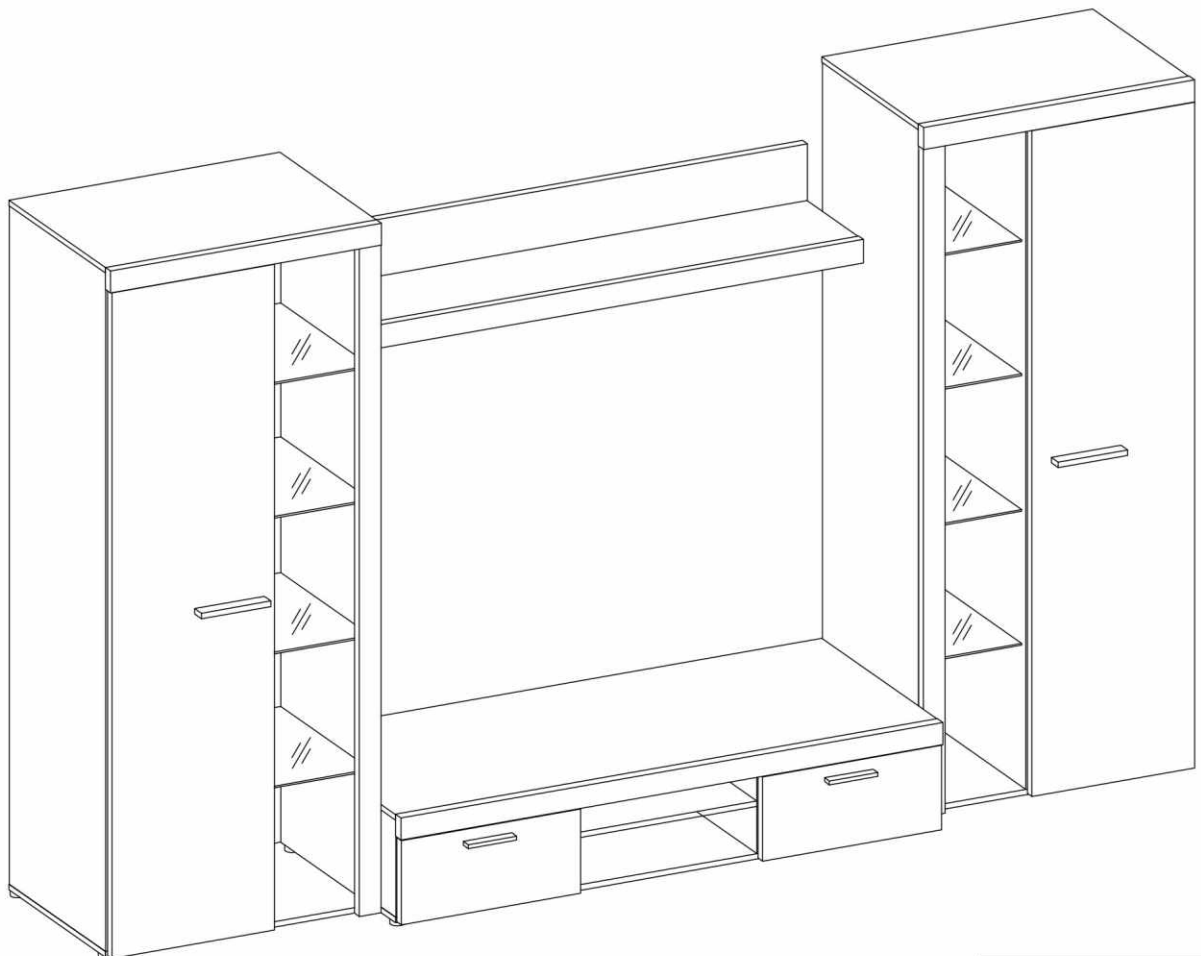
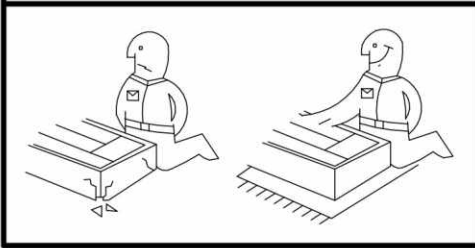
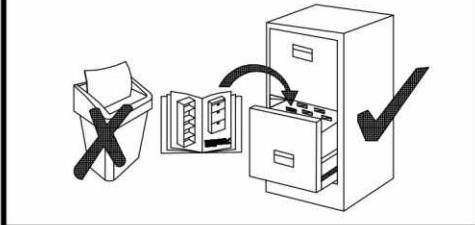
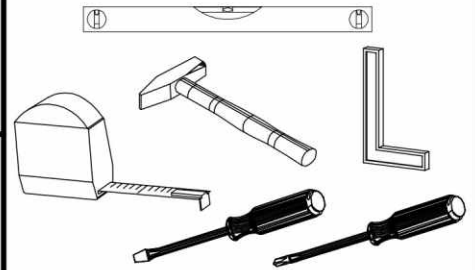

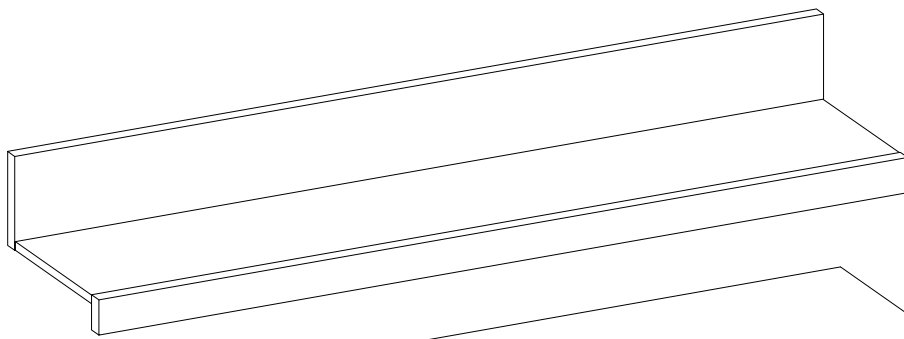

RBA.303 = max. 2kg



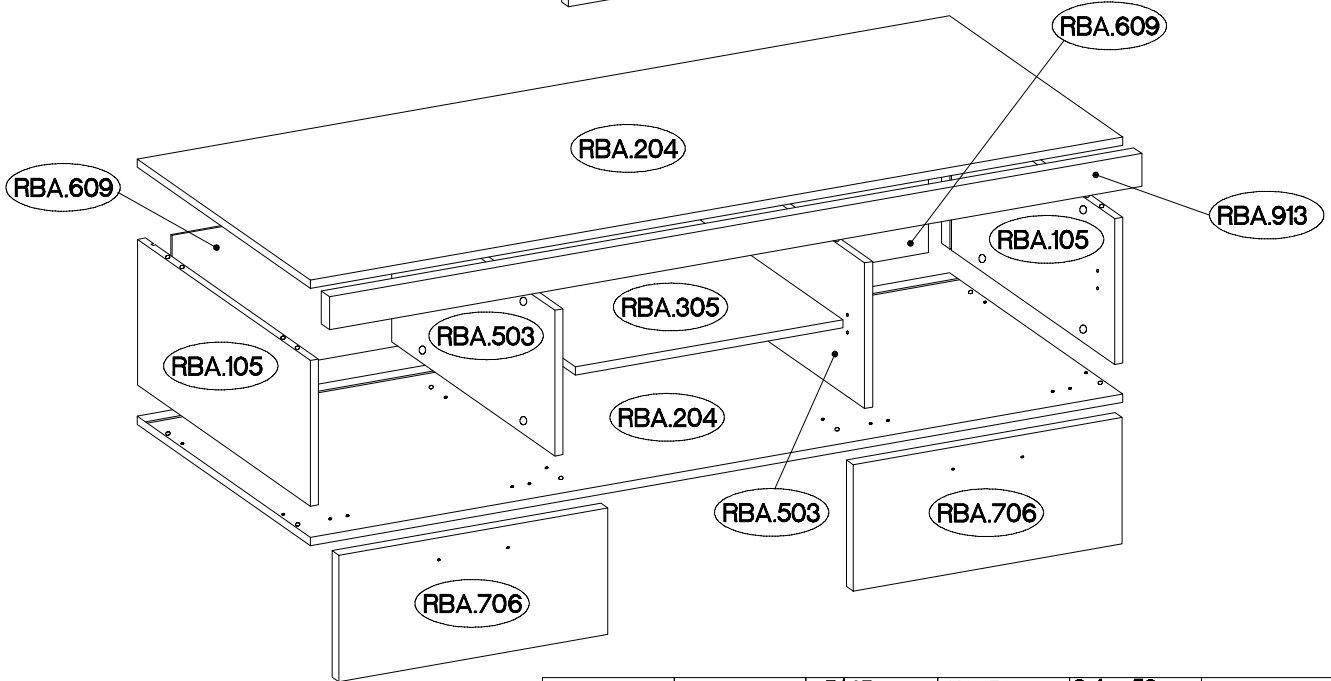
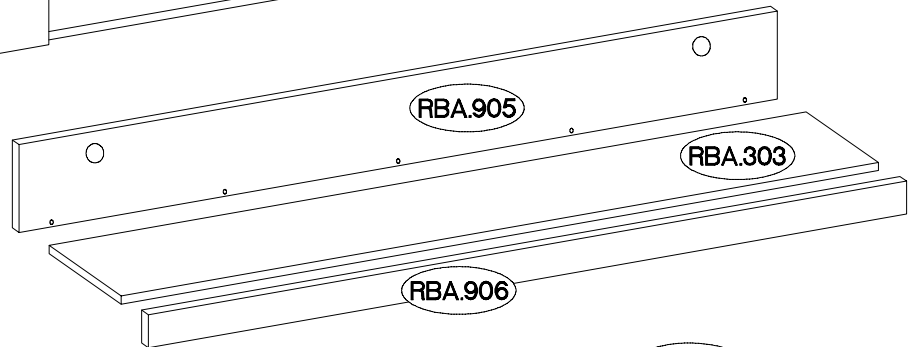
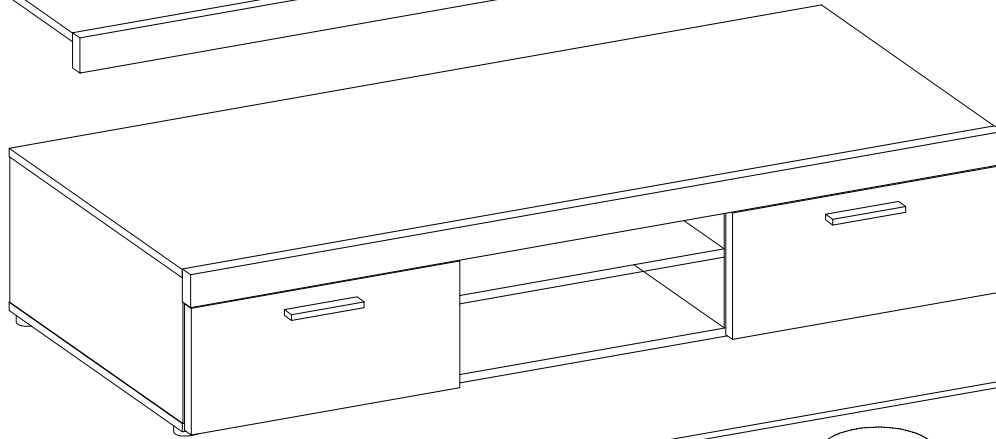

RBA.204 = max. 15kg

RBA.305



1B:	L=20mm	†5/12mm	†8x30mm		L=128mm	†4.0x30mm	†35/0mm		†3.5x13mm					
	D2	C	A	L	S1	R2	G	H	P5	F10				
	16	16	16	10	2	4	4	4	14	6				
			†6,3x9mm			5/45mm		†10x50mm		6,4 x 50mm			†7/2mm	
			M4	K7	O3	O7	B	O	J5					
			4	2	2	2	5	1	2					
				†3.0x20mm		†3.0x16mm	†4.0x16mm			†4.0x25mm				
			J1	P7	K13	P11	P1	T9	E	P14				
			4	4	2	6	18	9	16	6				

1

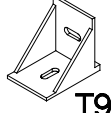
±6,3x9mm  M4 4	 K7 2	±7/2mm  J5 2	±4.0x16mm  P1 4	 T9 4
---	---	---	--	---

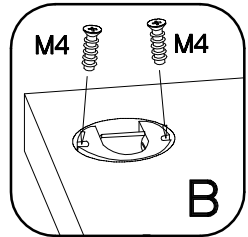
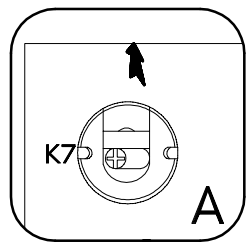
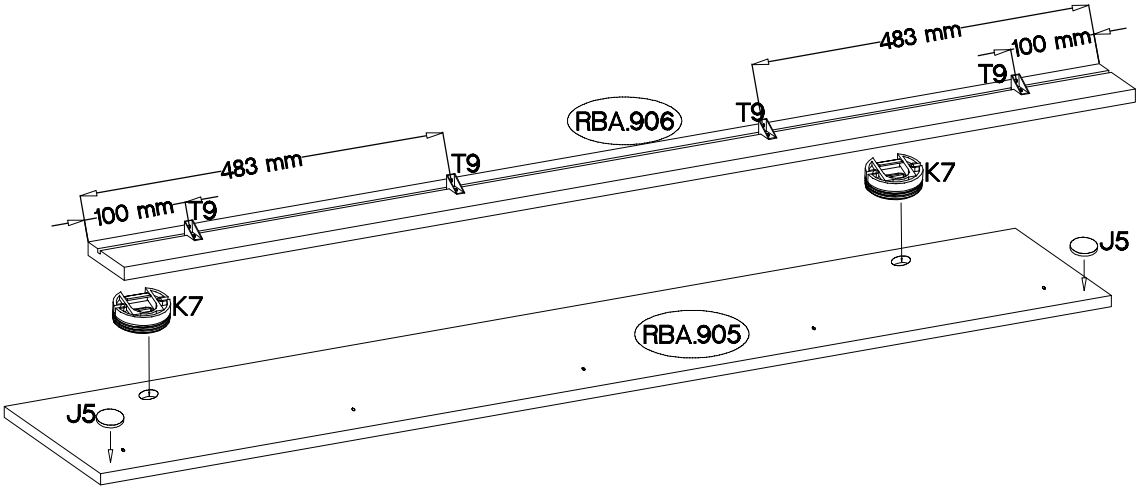
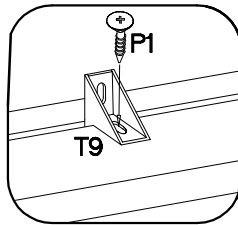

2

±4.0x16mm  P1 4
---

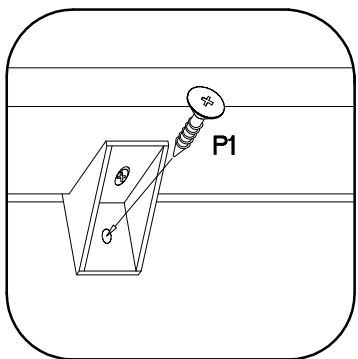
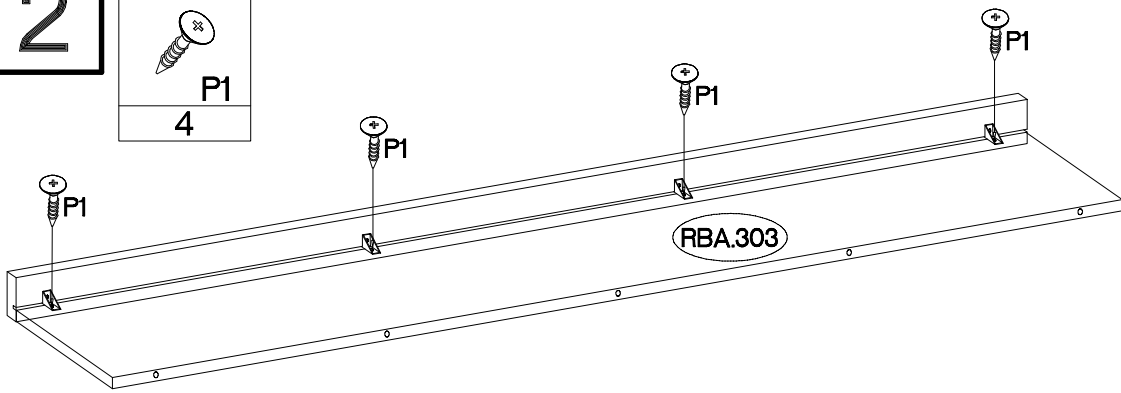

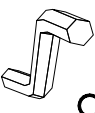

3

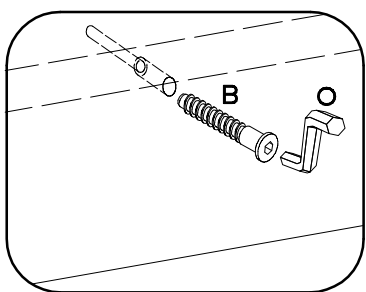
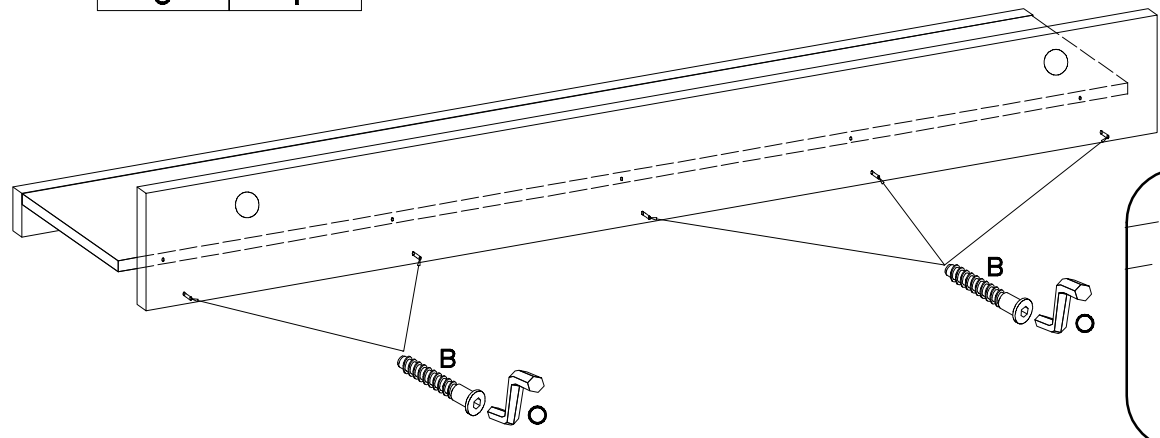



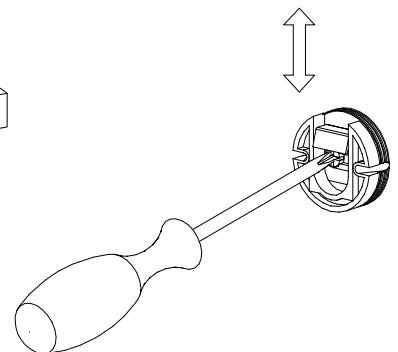
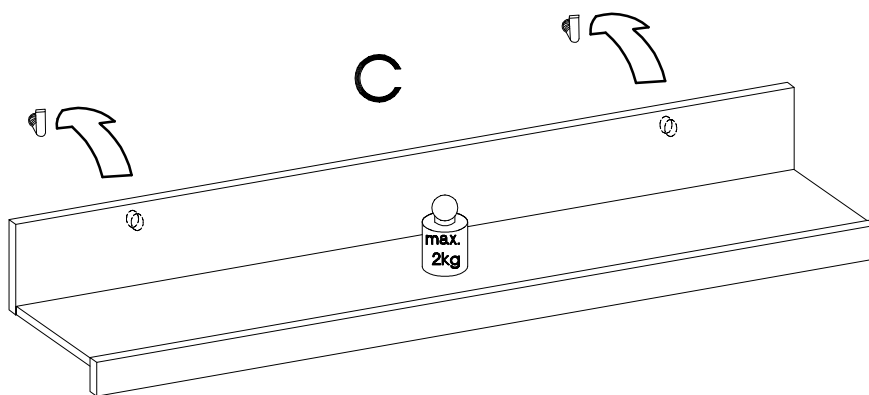
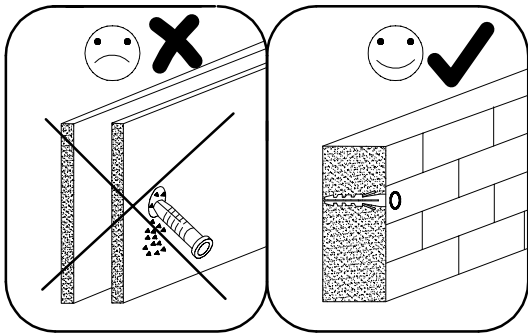
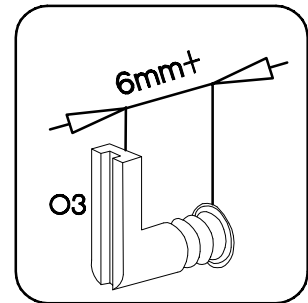
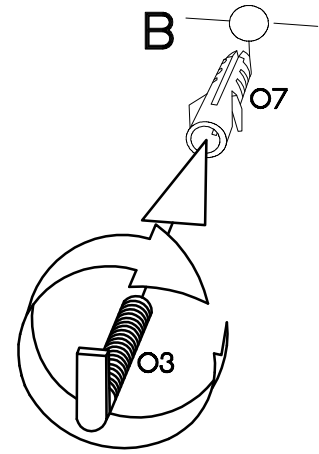
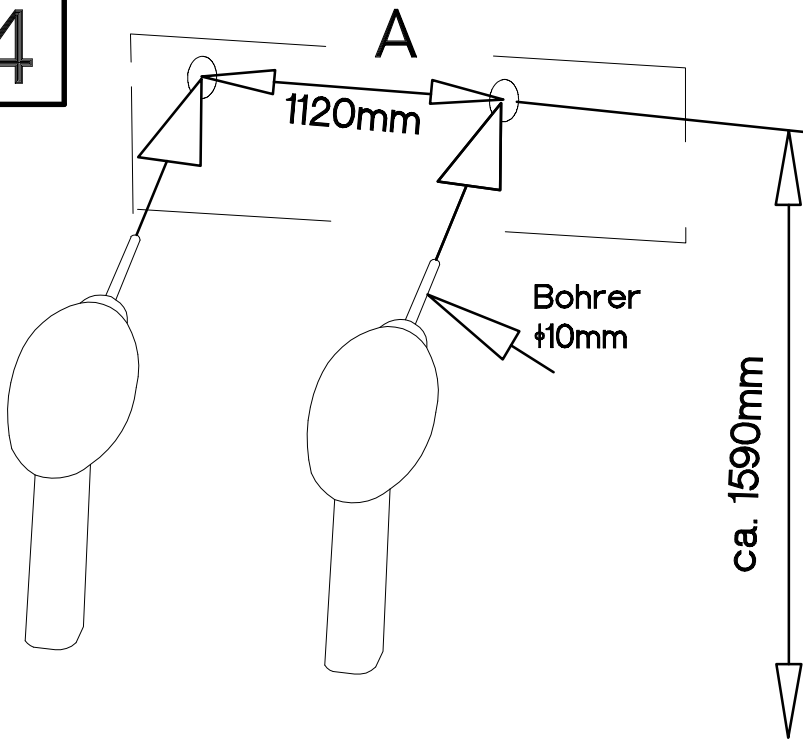

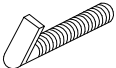
6,4 x 50mm  B 5	 O 1
---	---



4



5/45mm	$\varnothing$ 10x50mm
	
O3	O7
2	2

L=20mm 	±15/12mm 	±8x30mm 		±4.0x25mm 		±4.0x16mm 
D2	C	A	F10	P14	T9	P1
16	16	16	6	6	5	5

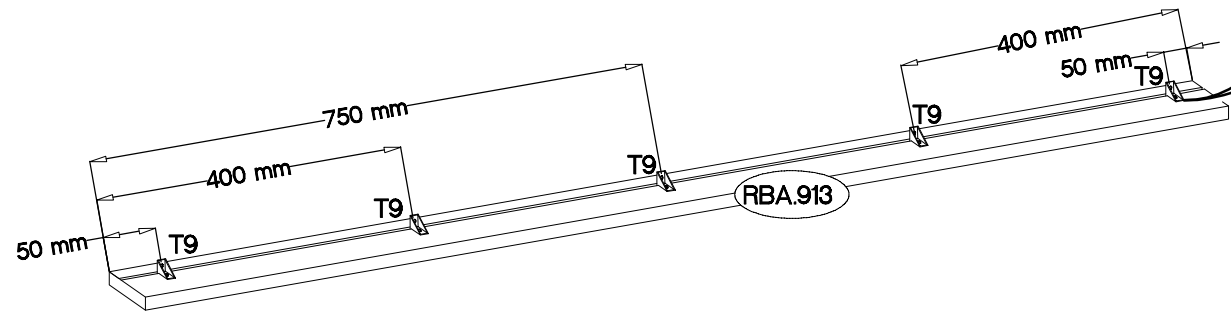
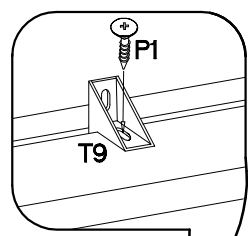
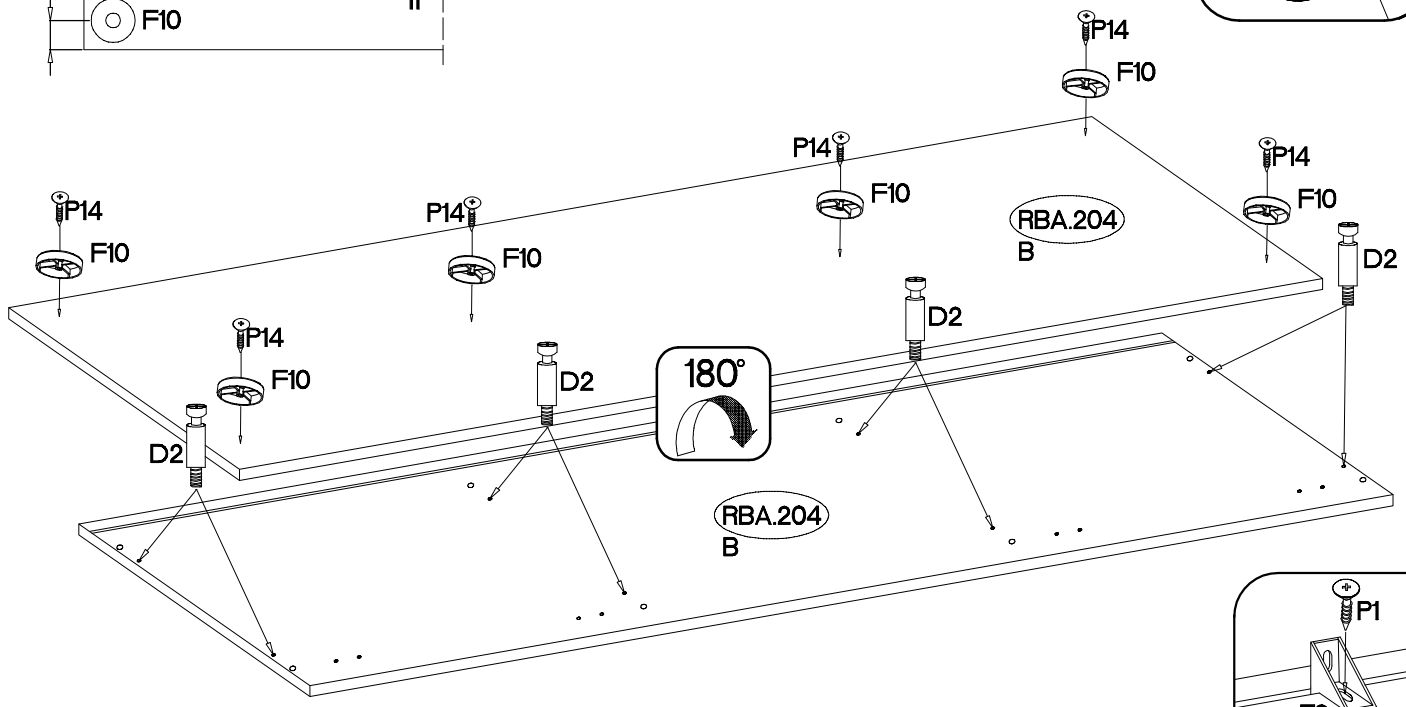
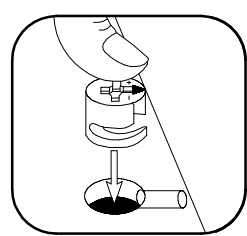
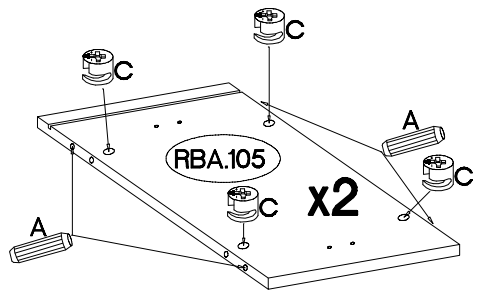
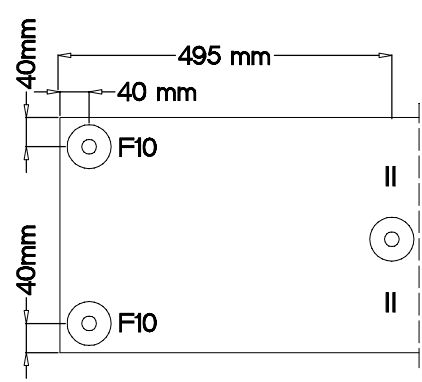
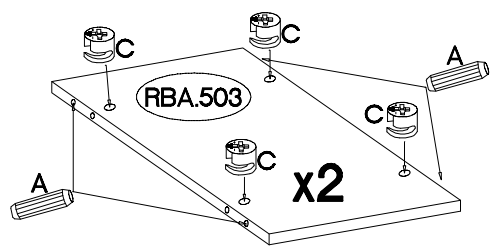
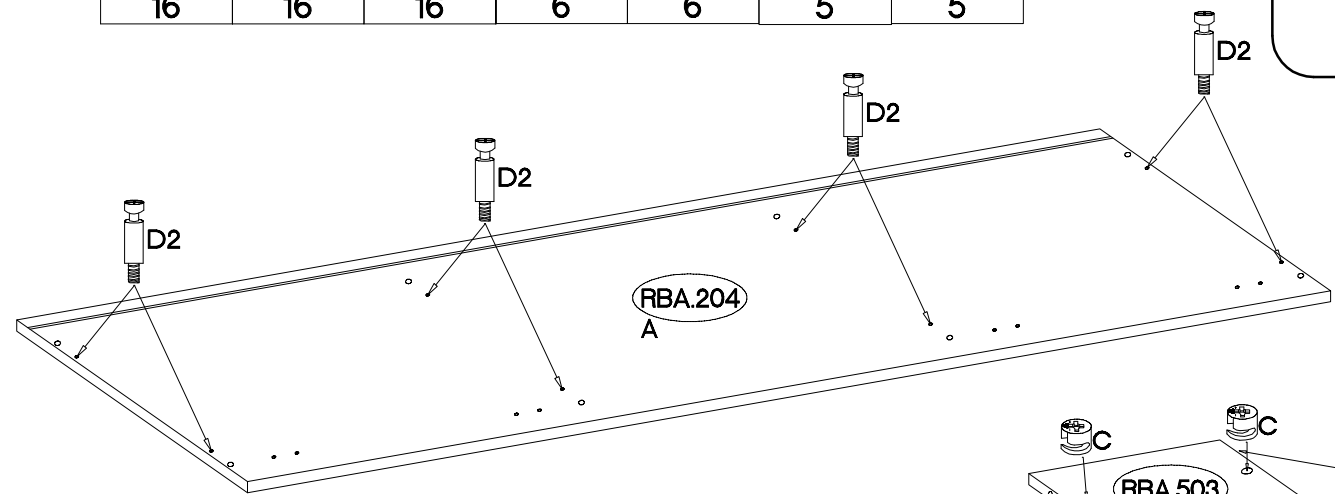
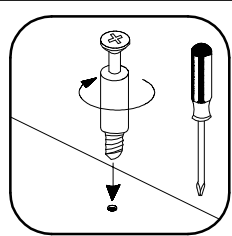

6

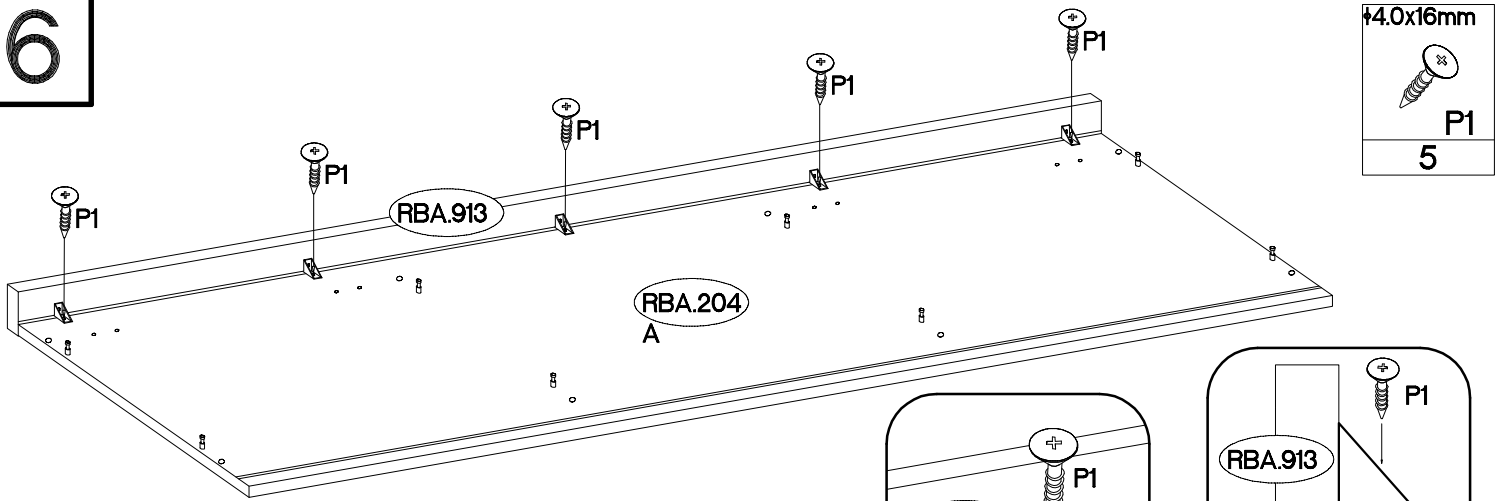

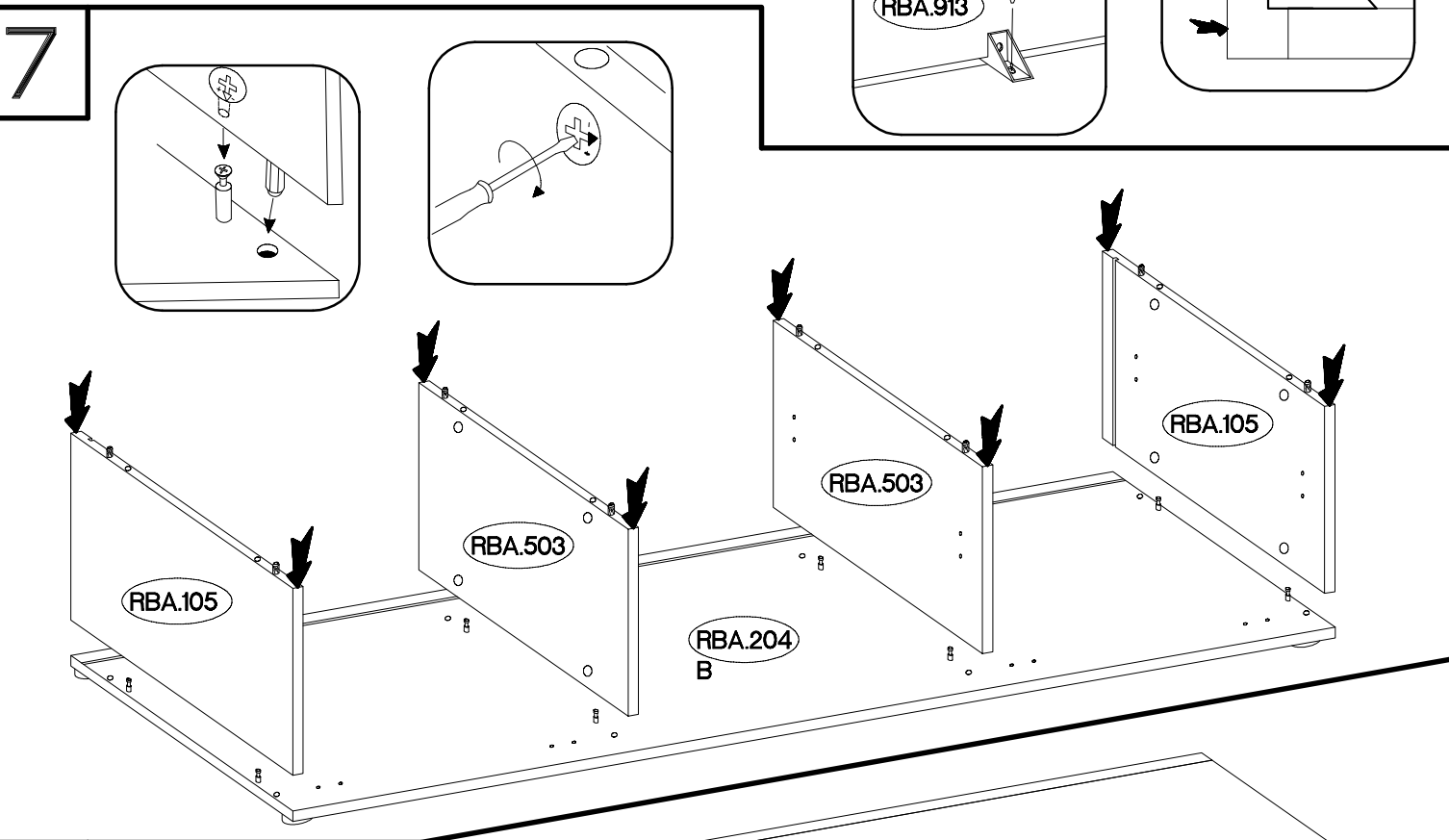

7

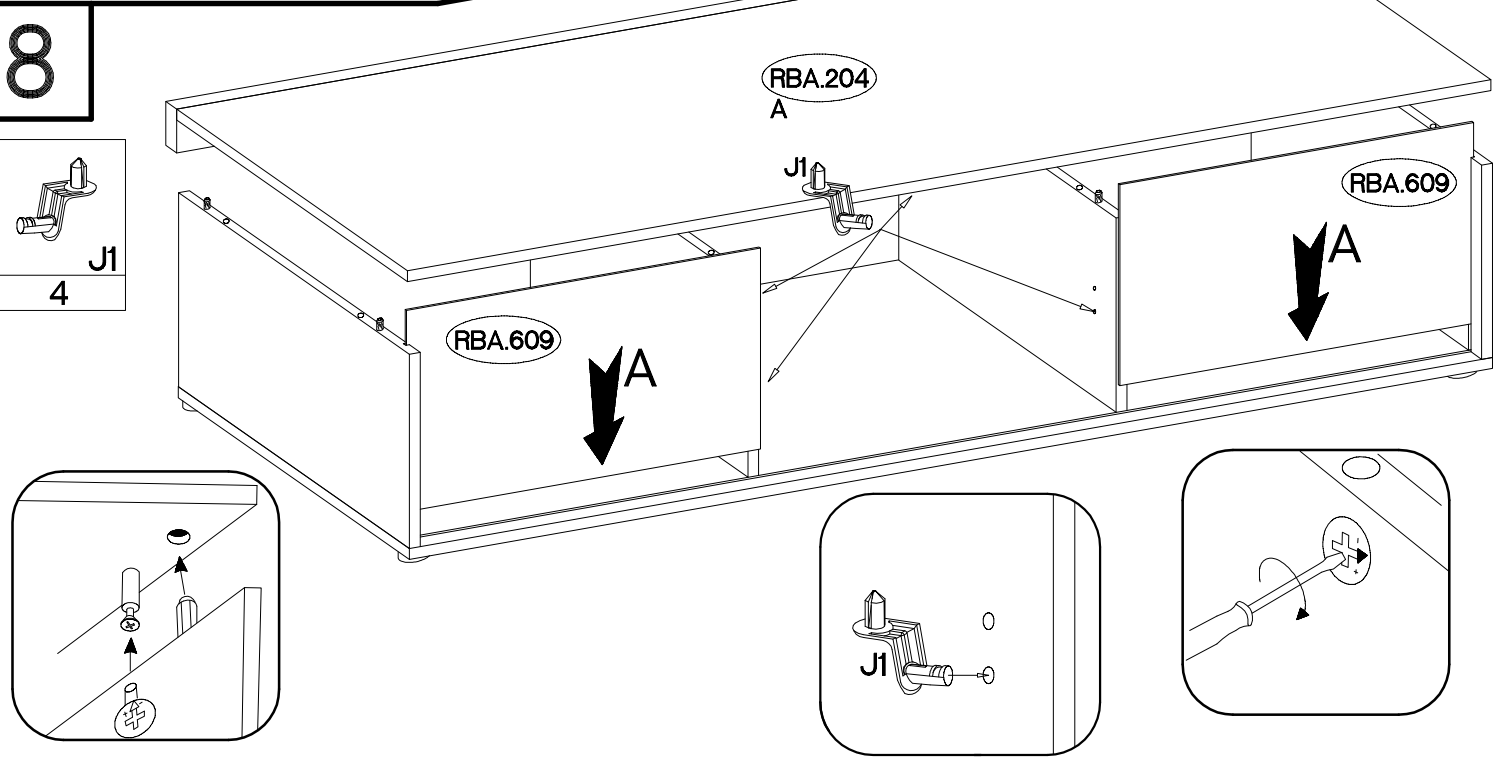

8





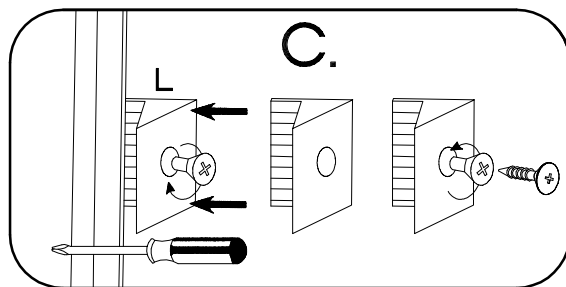
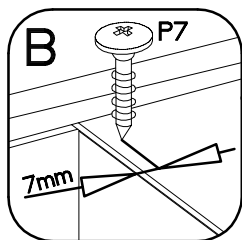
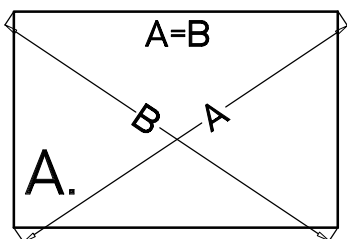
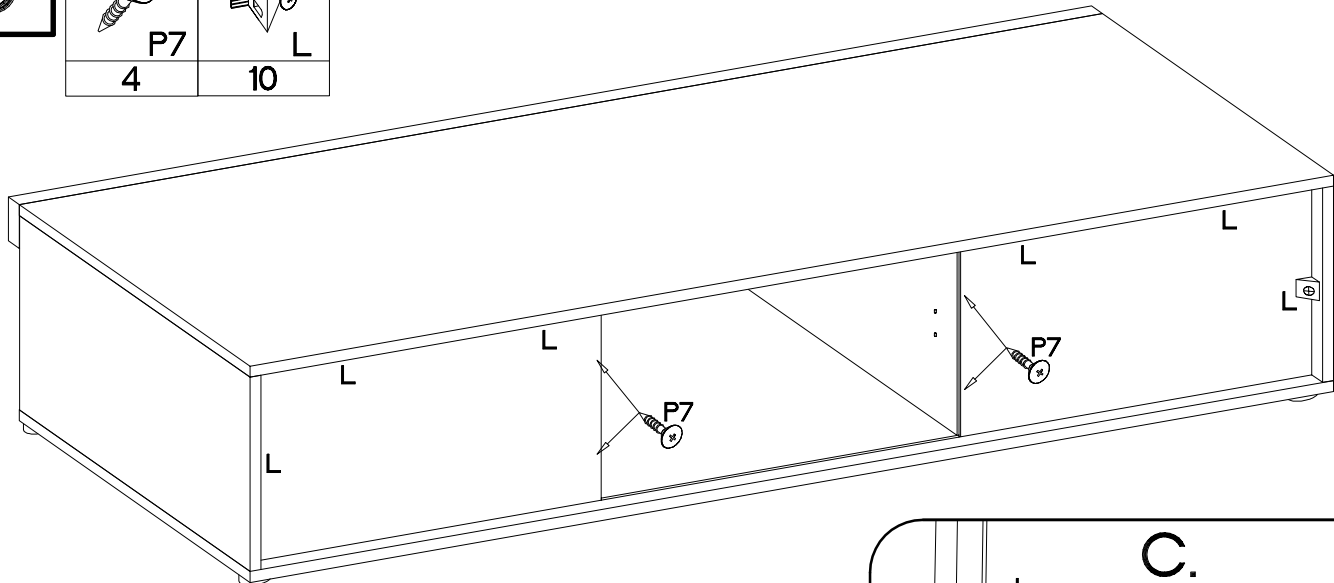

9

 P7 4	 L 10
---	---

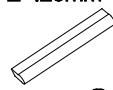

10

L=128mm

S1
2

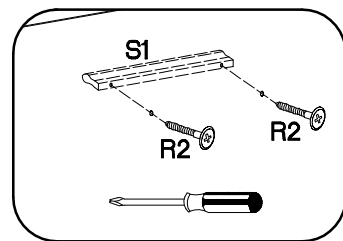
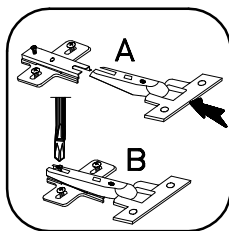
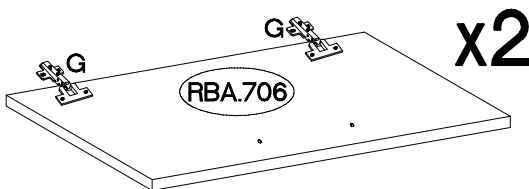
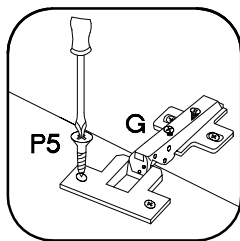
 G 4	 H 4
 P5 8	 R2 4

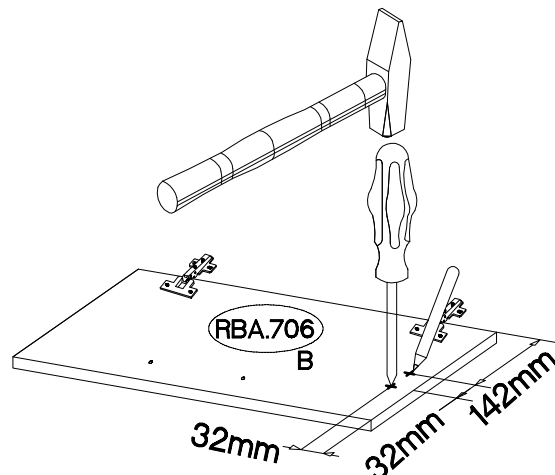
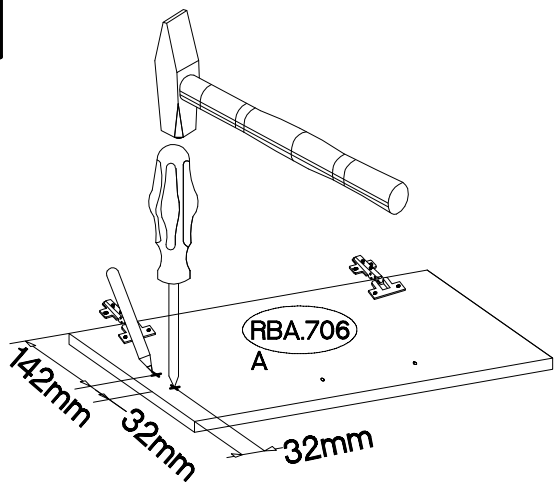

11

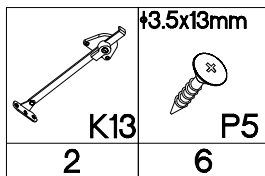
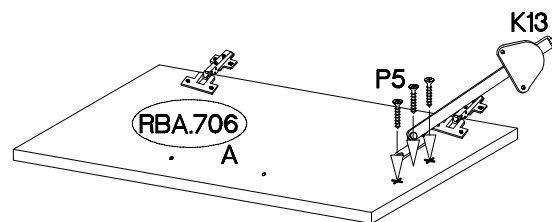
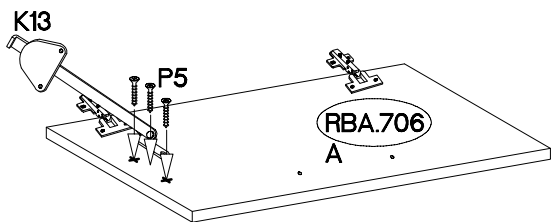
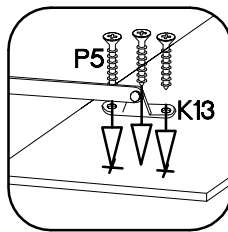



12

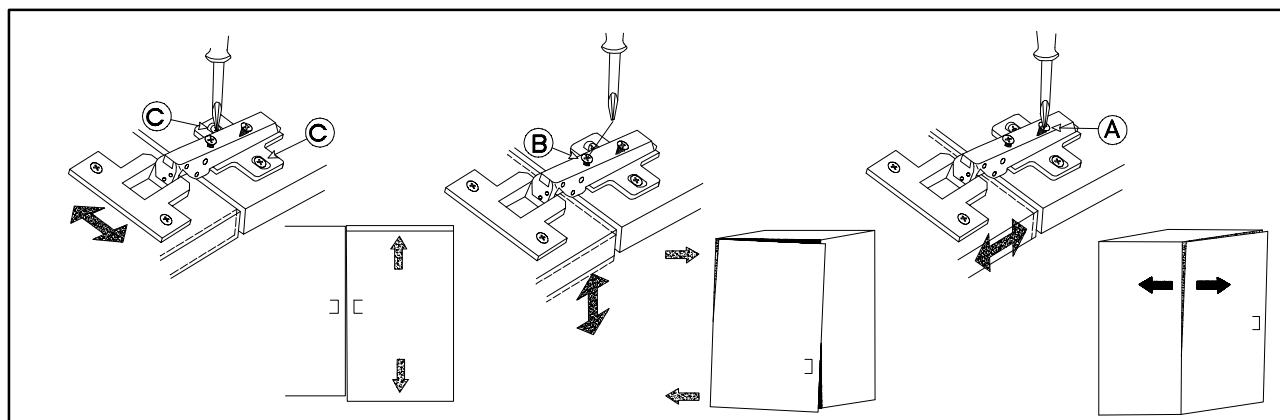
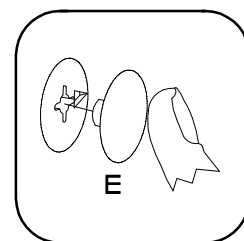
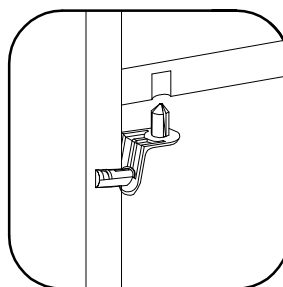
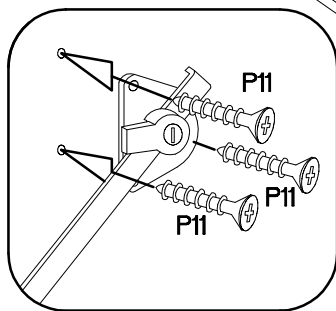
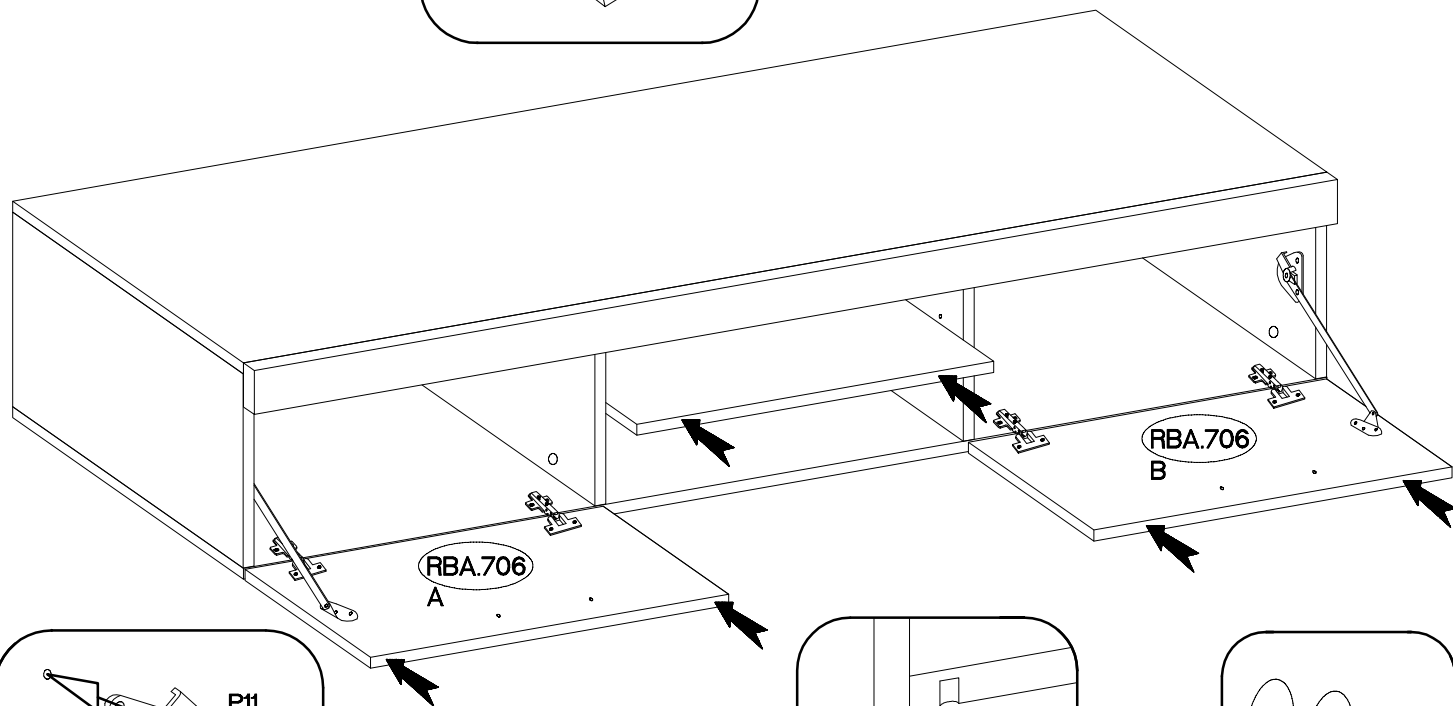
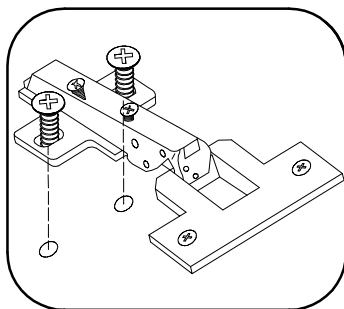
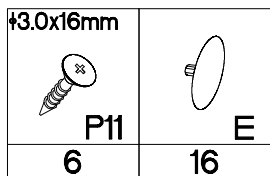



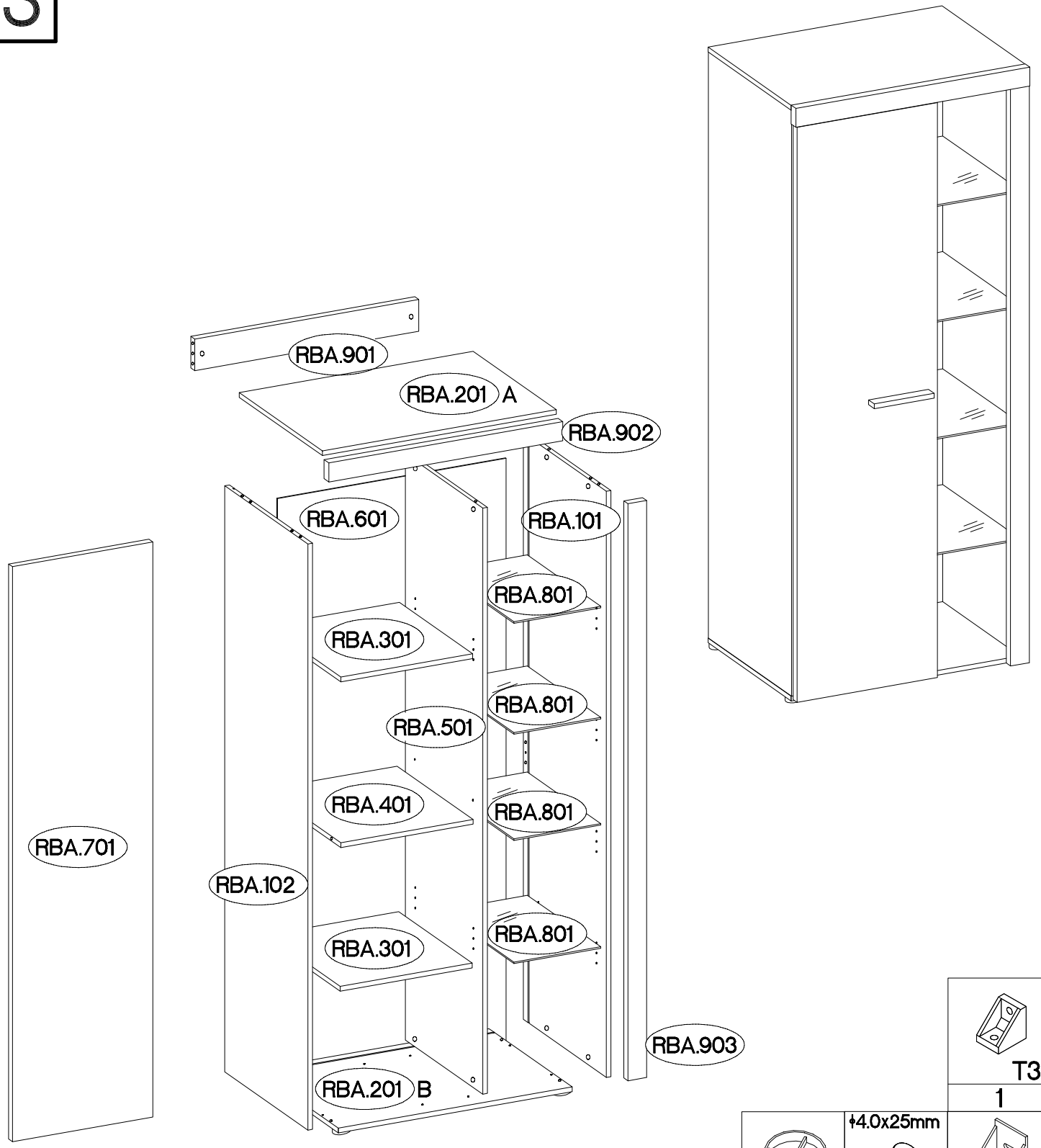

	T3
1	

	$\pm 4.0 \times 25 \text{mm}$	
F10	P14	T9
5	5	7

$\pm 10 \times 50 \text{mm}$					$\pm 3.5 \times 13 \text{mm}$			$\pm 4.0 \times 16 \text{mm}$				
O7	L9	E	J12	P5	L2	P1	H	T4				
1	1	16	16	7	10	20	3	1				
$\pm 4.0 \times 30 \text{mm}$	$\pm 3.0 \times 20 \text{mm}$	L=20mm	$\pm 15/12 \text{mm}$	$\pm 8 \times 30 \text{mm}$			L=128mm	$\pm 5/16 \text{mm}$	$\pm 35/0 \text{mm}$			
R2	P7	D2	C	A	12	S1	J3	G				
2	10	18	18	12	12	1	8	3				

**2B** :

L=20mm 	±15/12mm 	±8x30mm 				±4.0x16mm 		±4.0x25mm 
D2	C	A	T9	T4	T3	P1	F10	P14
18	18	12	7	1	1	10	5	5

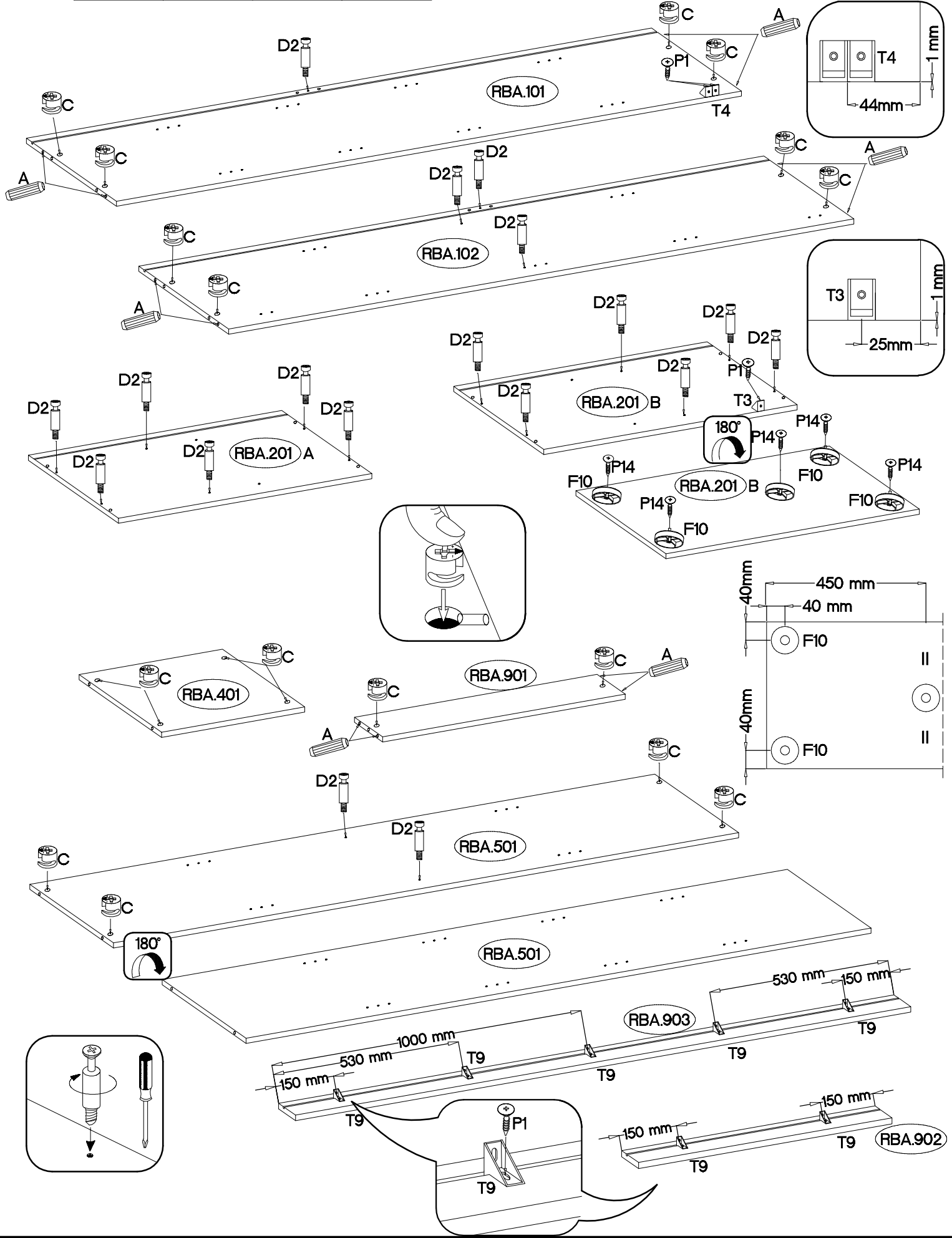

15

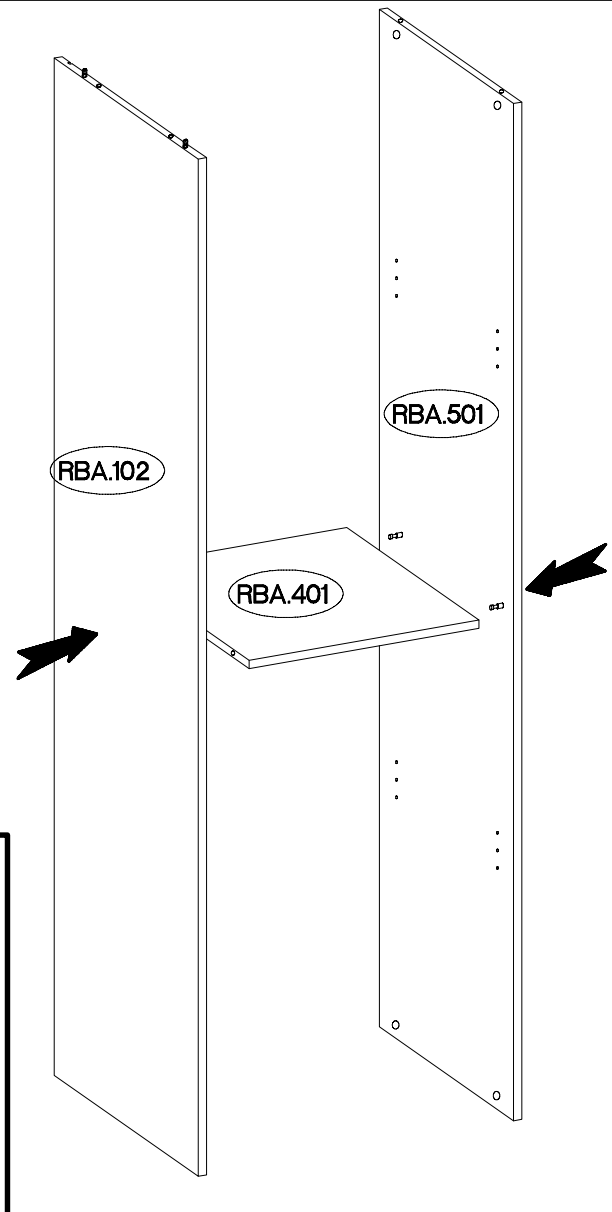
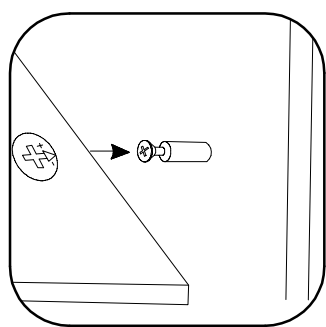
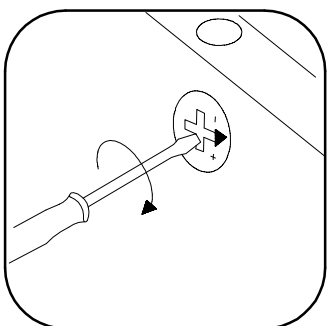

16

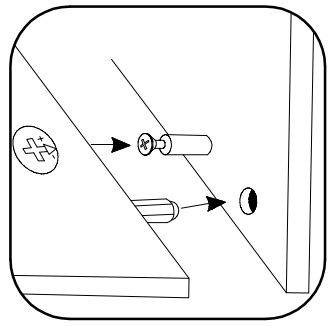
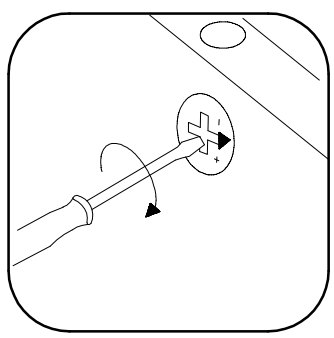
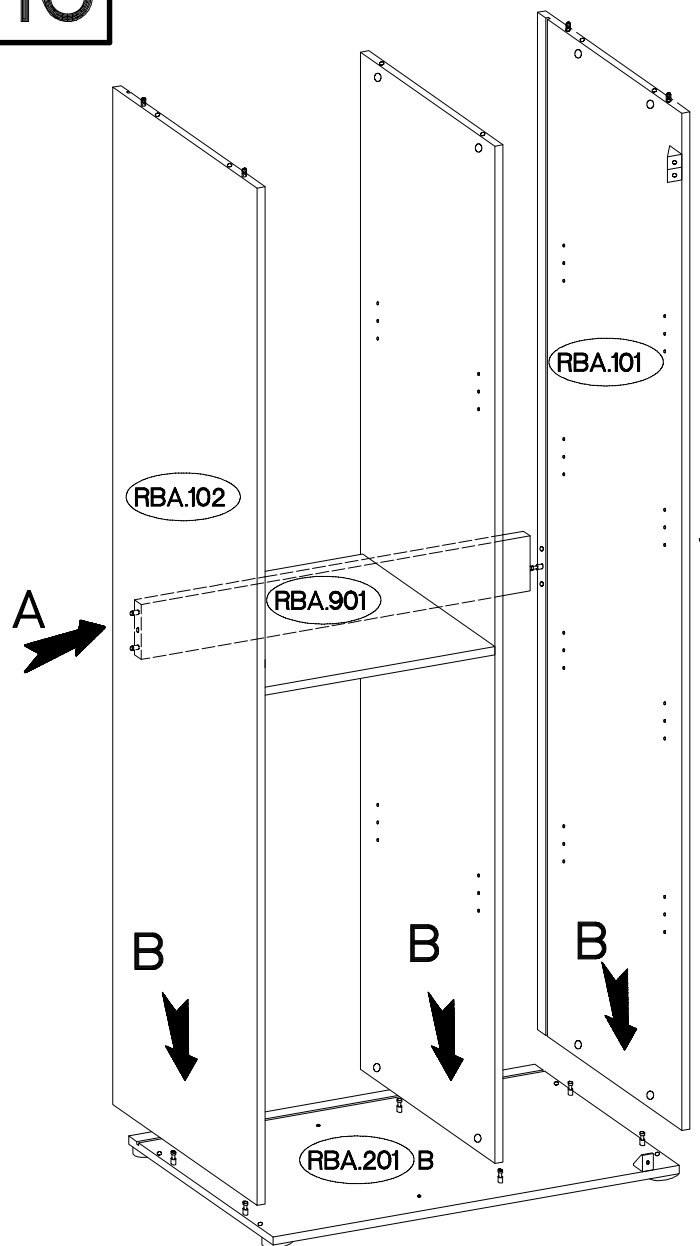

17

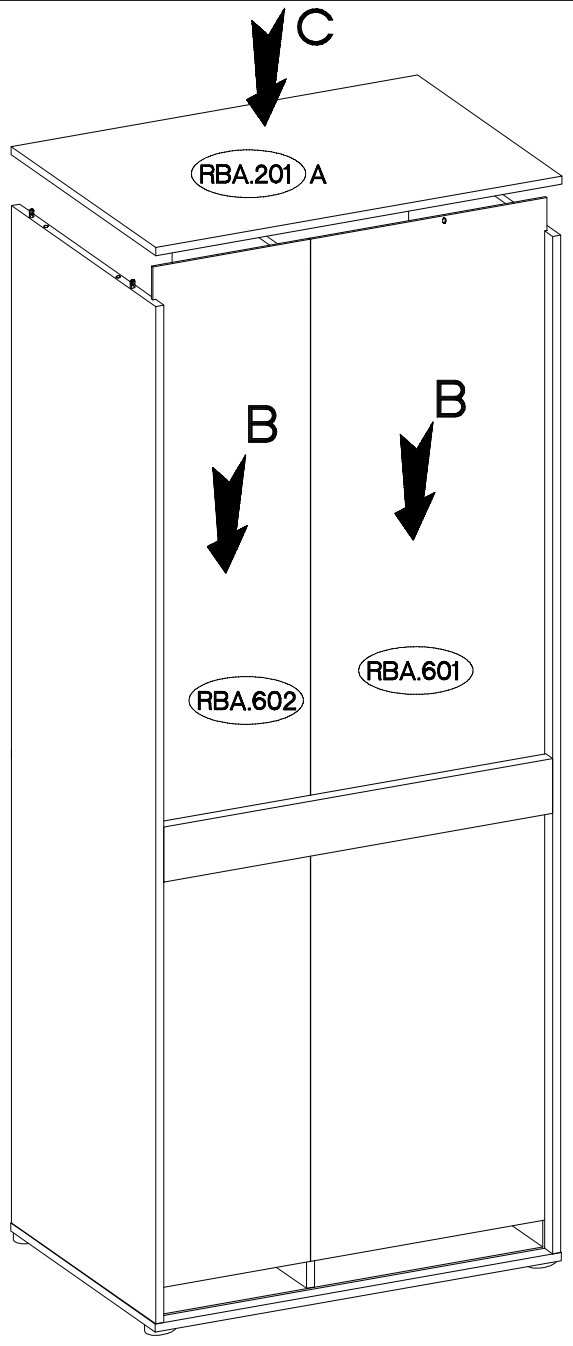
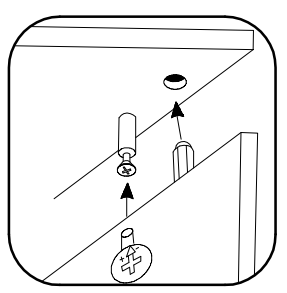
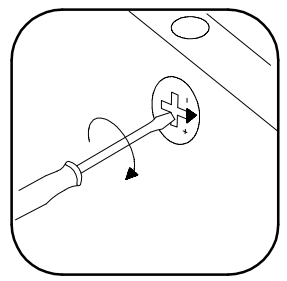
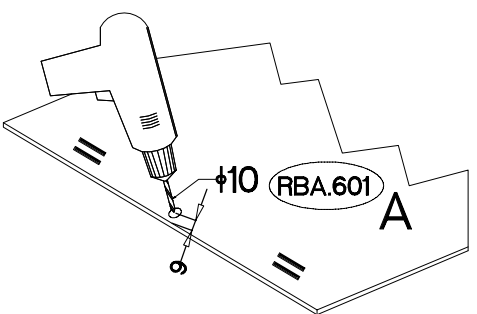

18

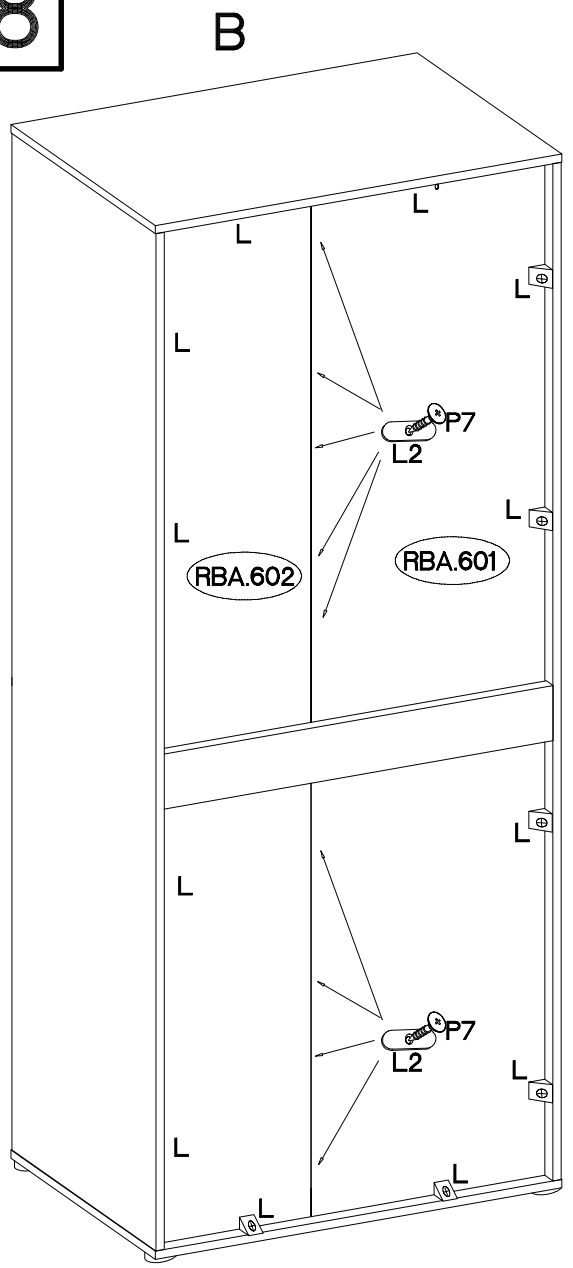

$\phi 3.0 \times 20 \text{mm}$		
P7	L2	L
9	9	12

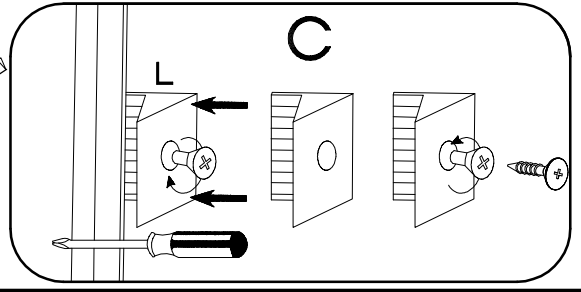
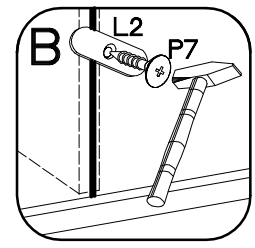
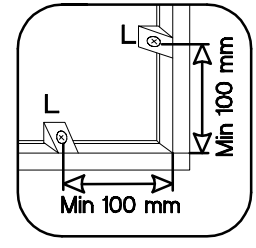
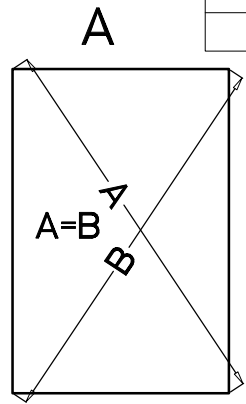

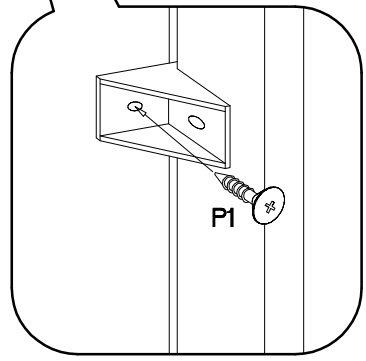
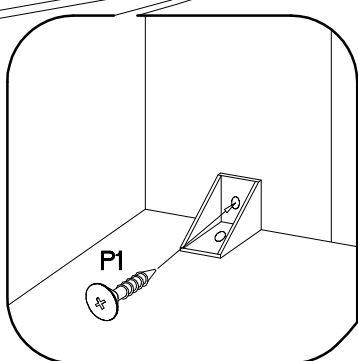
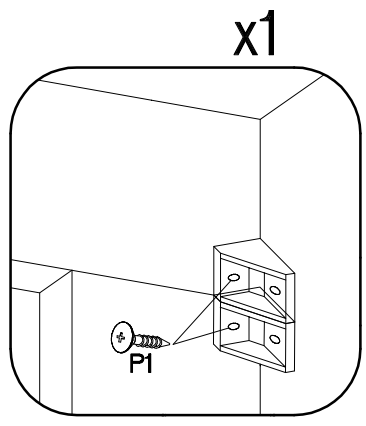
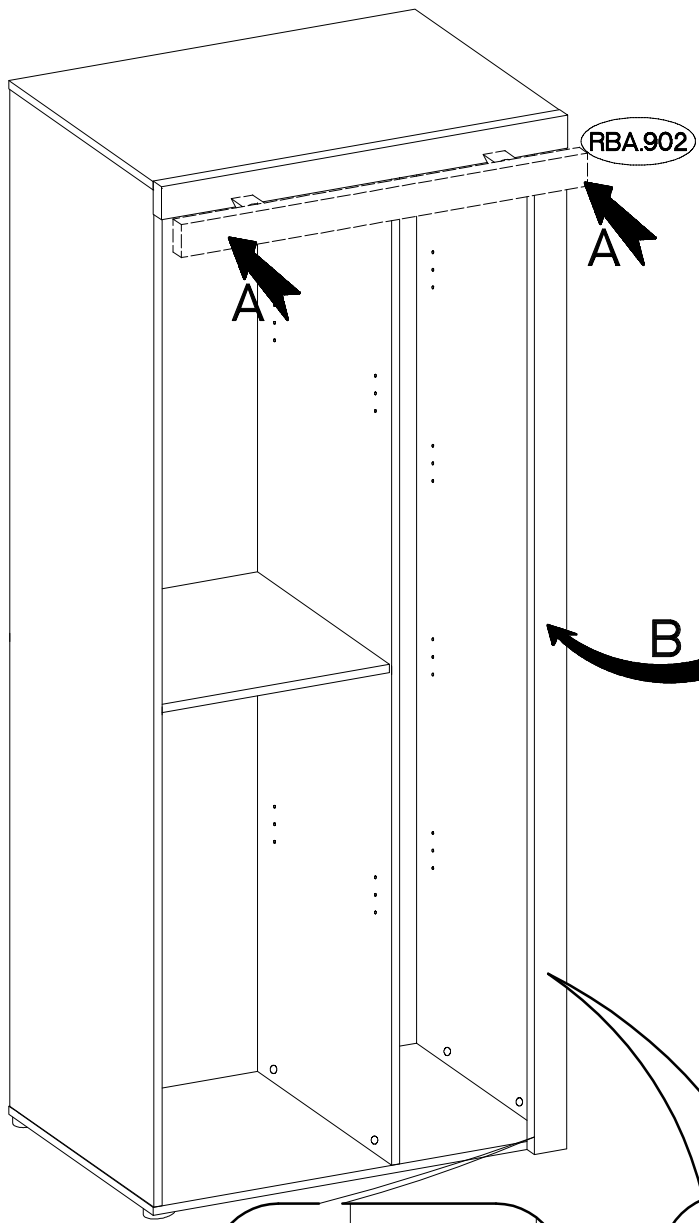

19

±4.0x16mm

P1
10

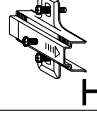
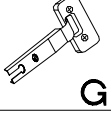



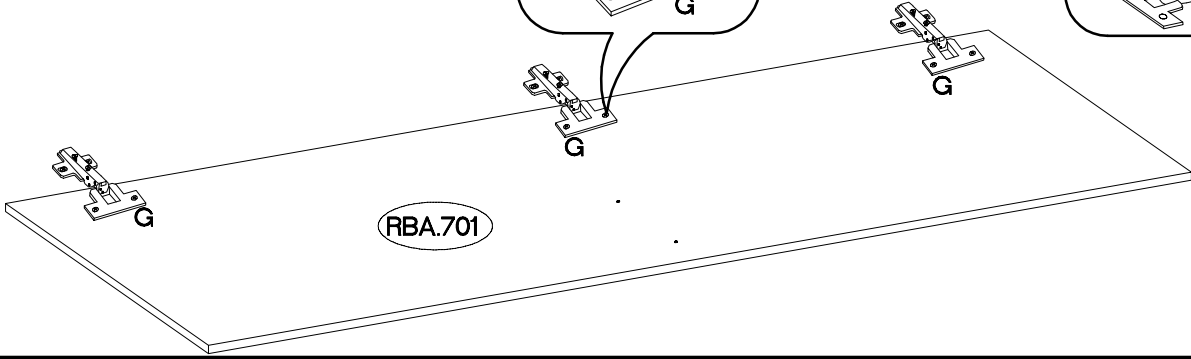
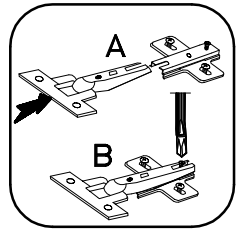
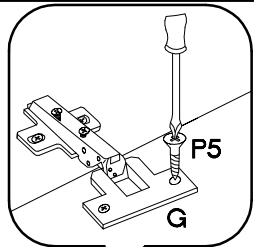

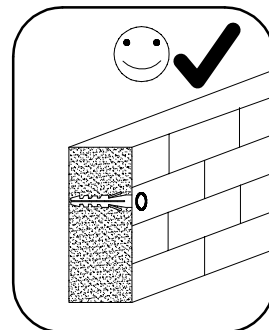
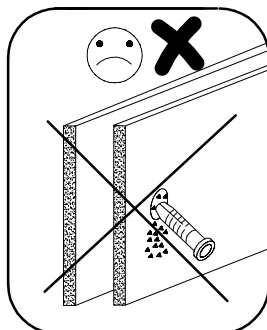
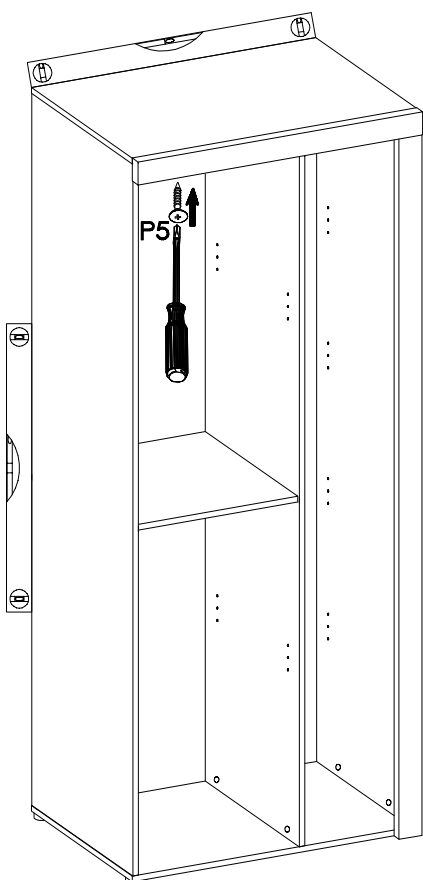
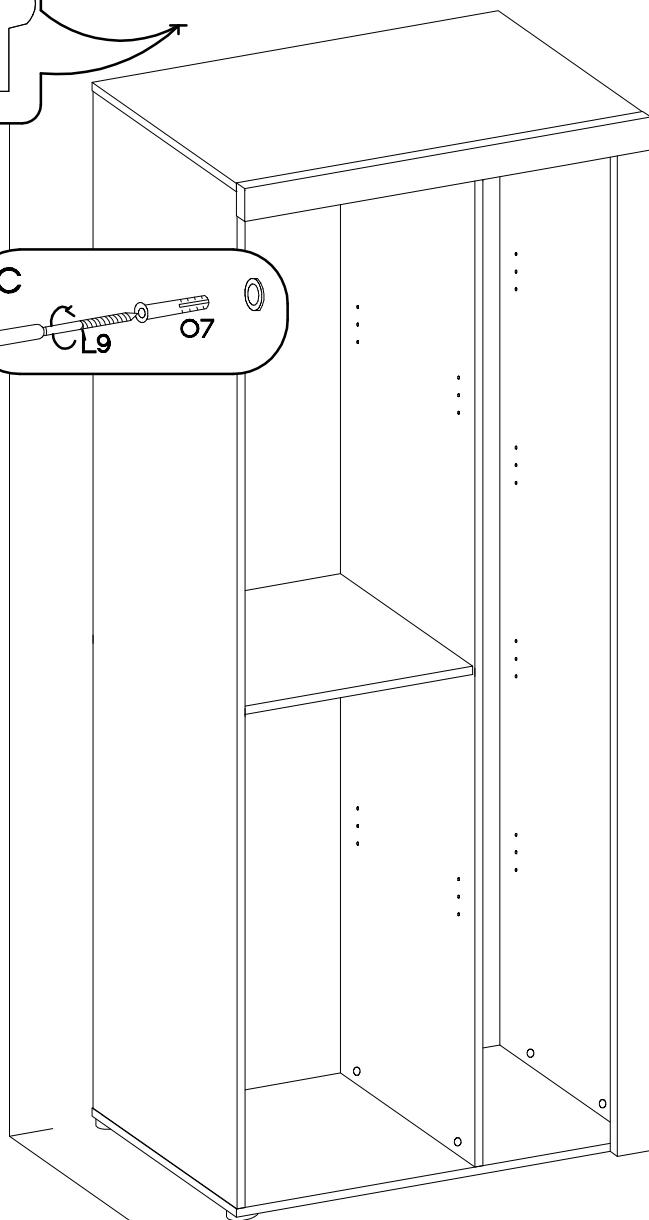
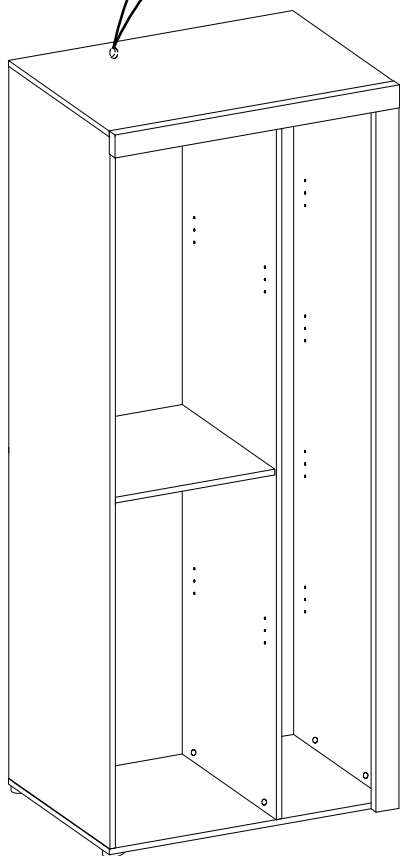
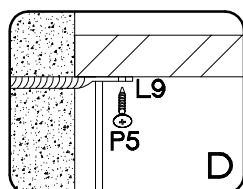
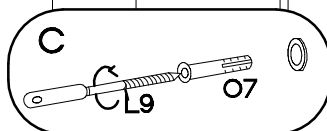
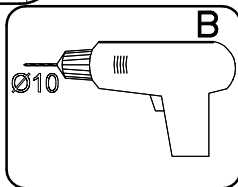
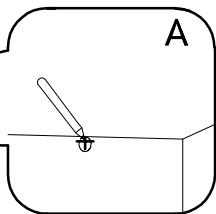
20

H=0	±35/0mm	±3.5x13mm
		
H	G	P5
3	3	6

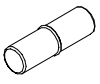

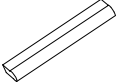

 <p>±5/16mm</p> <p><b>J3</b></p> <p>8</p>	 <p><b>E</b></p> <p>16</p>	 <p><b>J12</b></p> <p>16</p>	 <p>±4.0x30mm</p> <p><b>R2</b></p> <p>2</p>	 <p>L=128mm</p> <p><b>S1</b></p> <p>1</p>
---	--	--	---	---

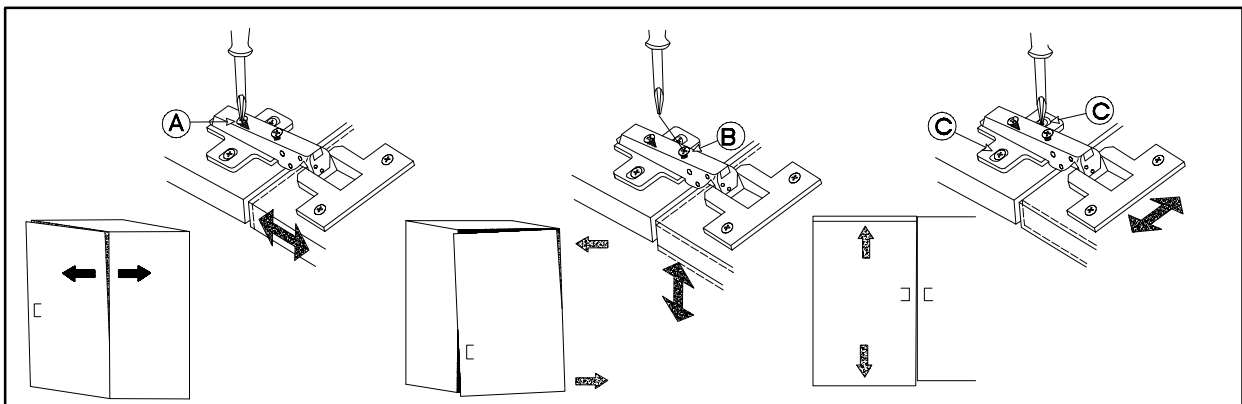
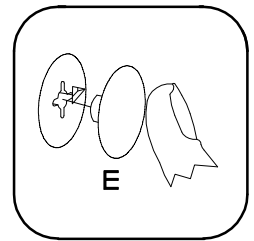
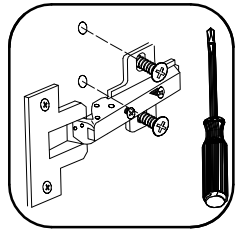
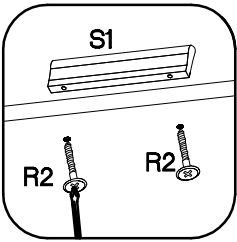
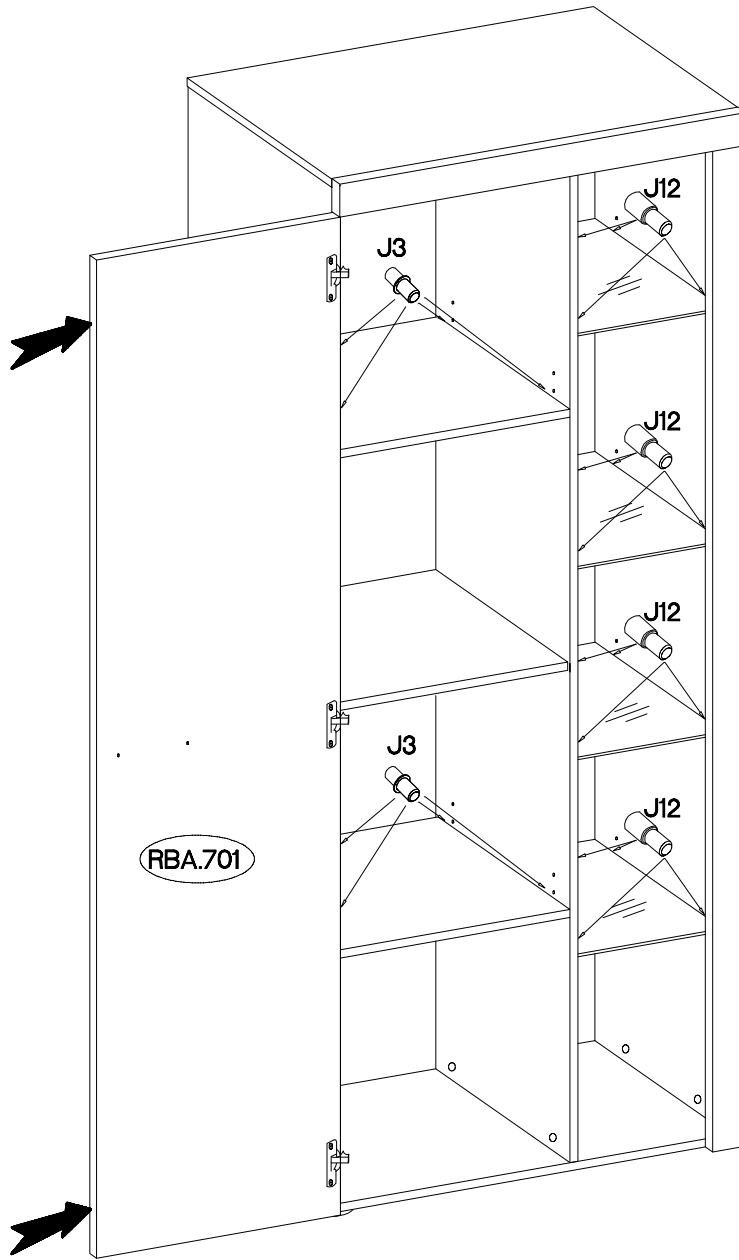

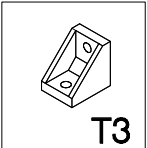
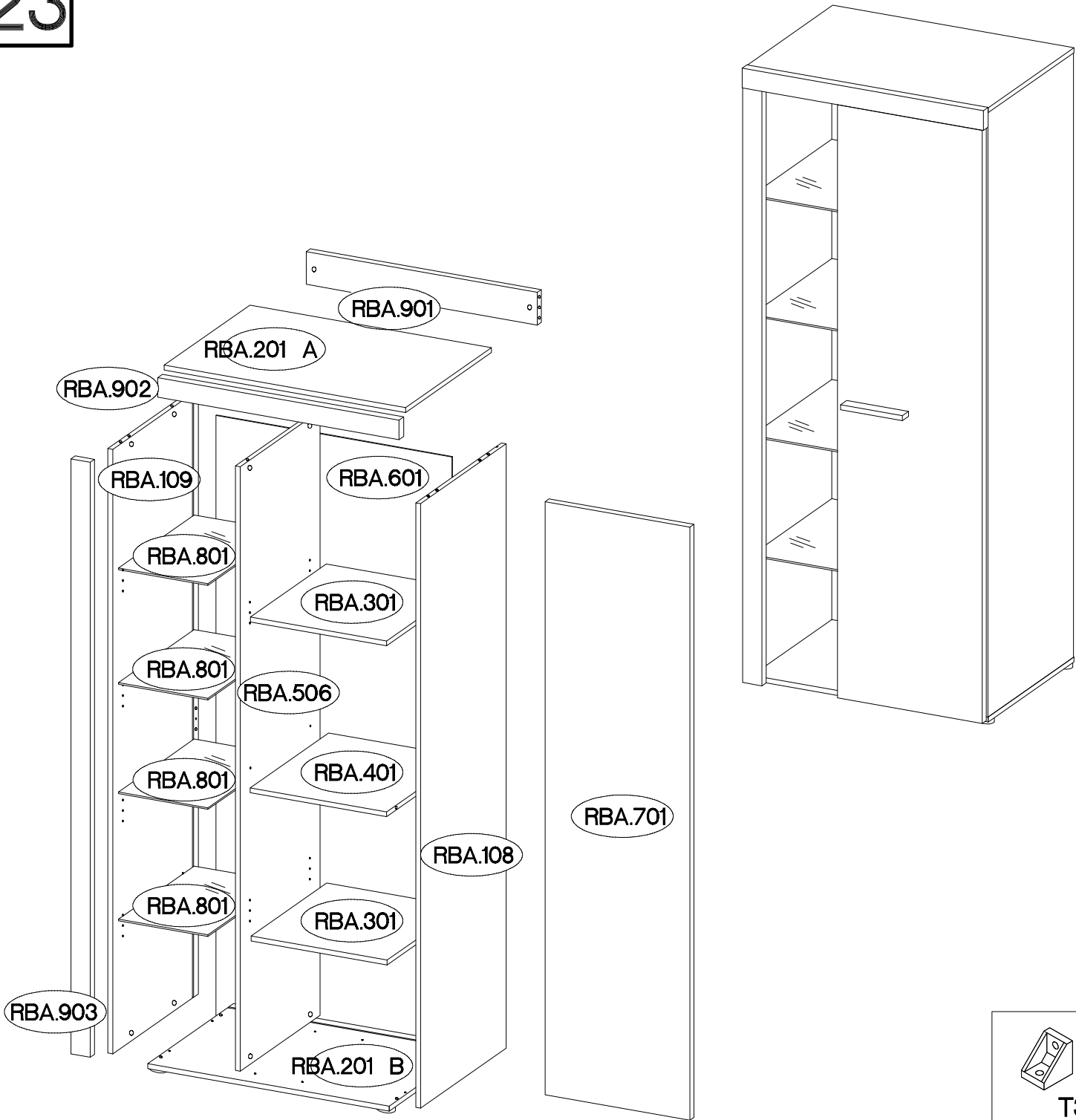

T3

1

F10	P14	T9
5	5	7

O7	L9	E	J12	P5	L2	P1	H	T4
1	1	16	16	7	10	20	3	1
R2	P7	D2	C	A	12	S1	J3	G
2	10	18	18	12	12	1	8	3

3B :



L=20mm 	±15/12mm 	±8x30mm 				±4.0x16mm 		±4.0x25mm 
D2	C	A	T9	T4	T3	P1	F10	P14
18	18	12	7	1	1	10	5	5

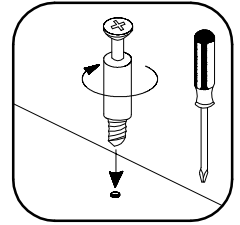
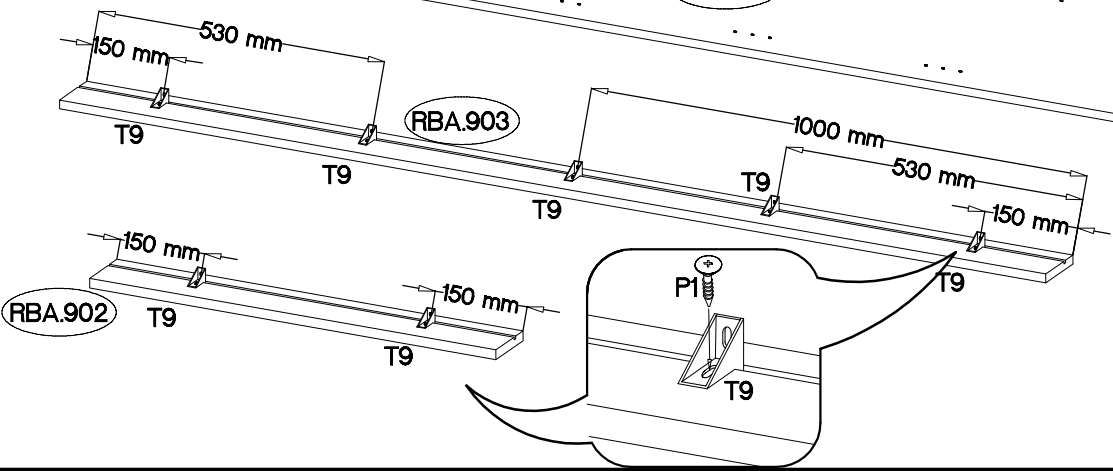
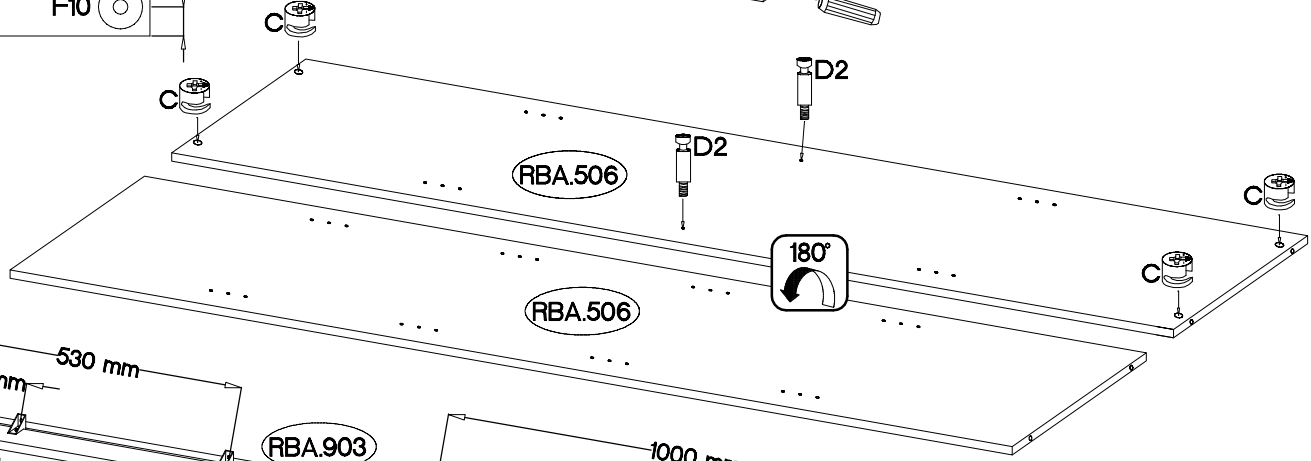
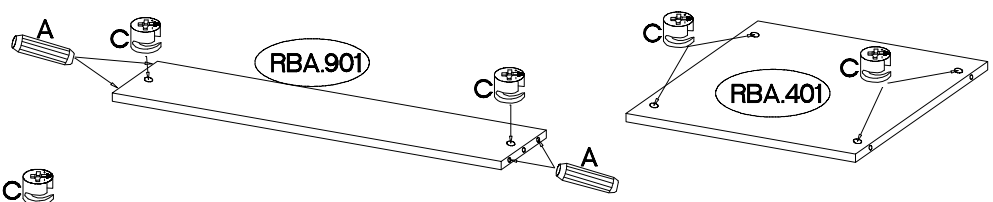
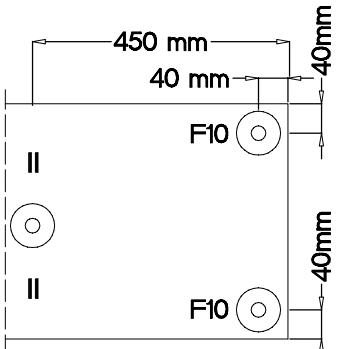
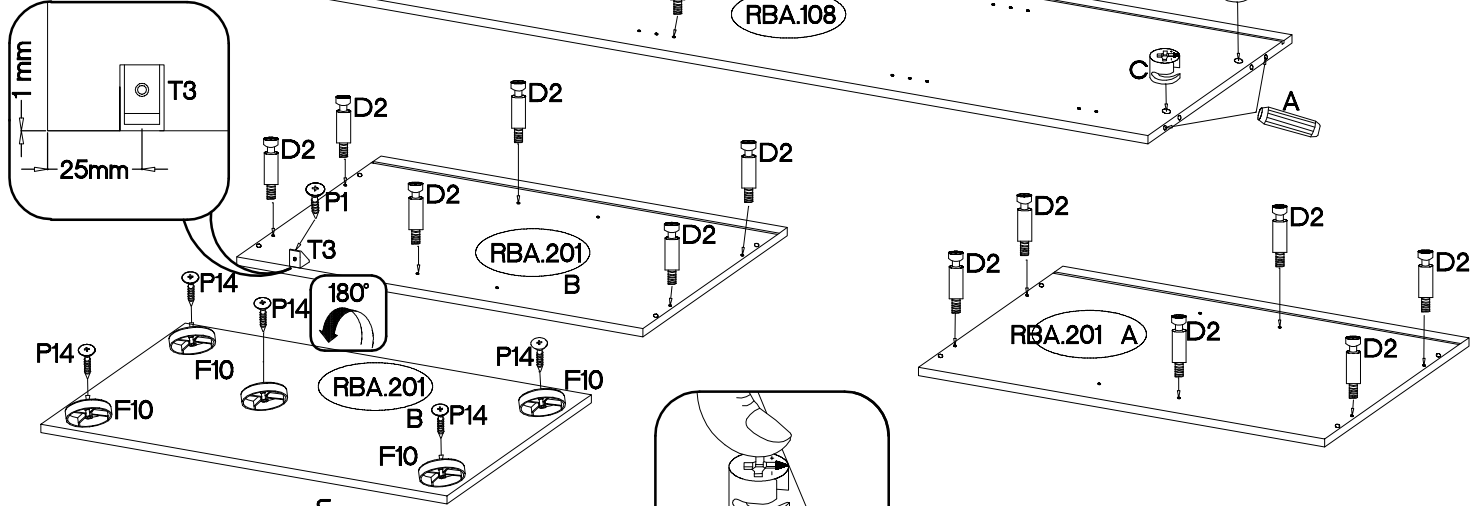
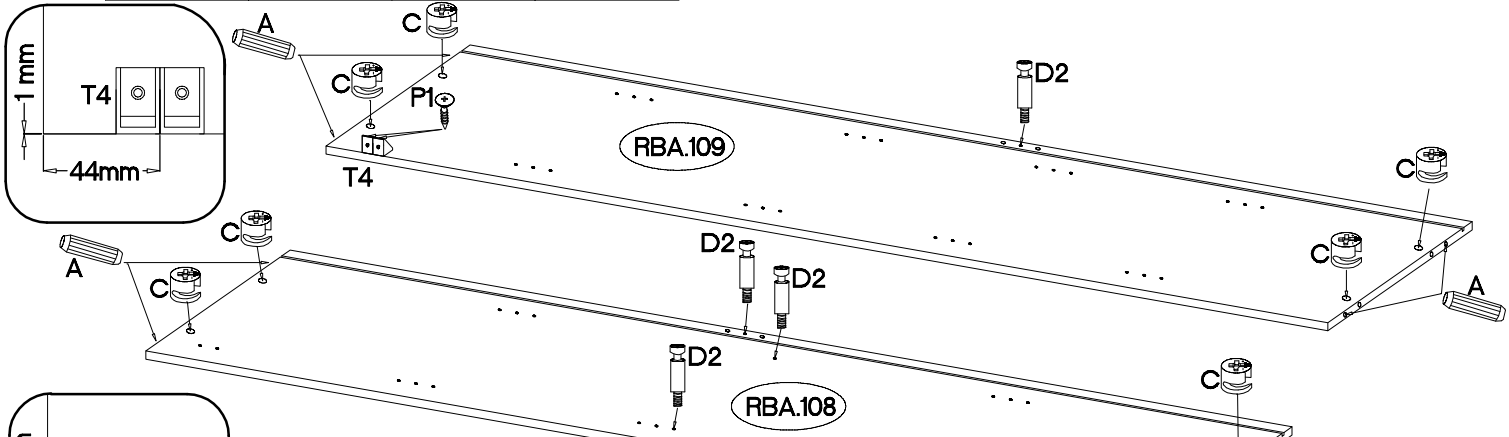

25

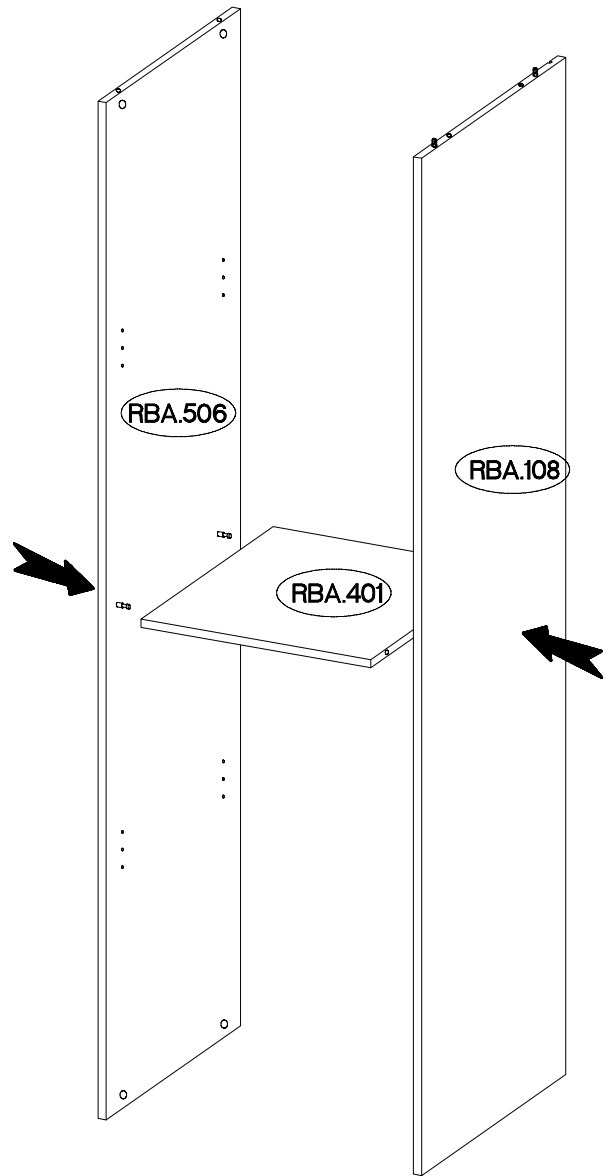
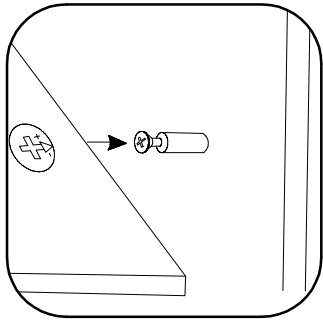
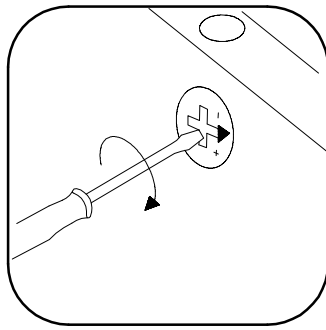

26

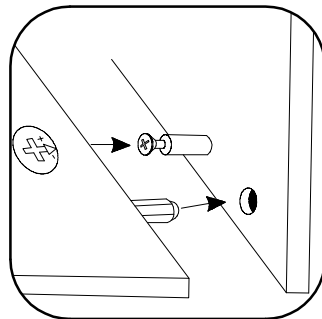
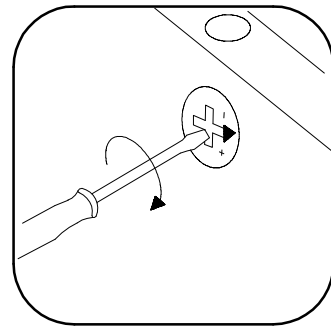
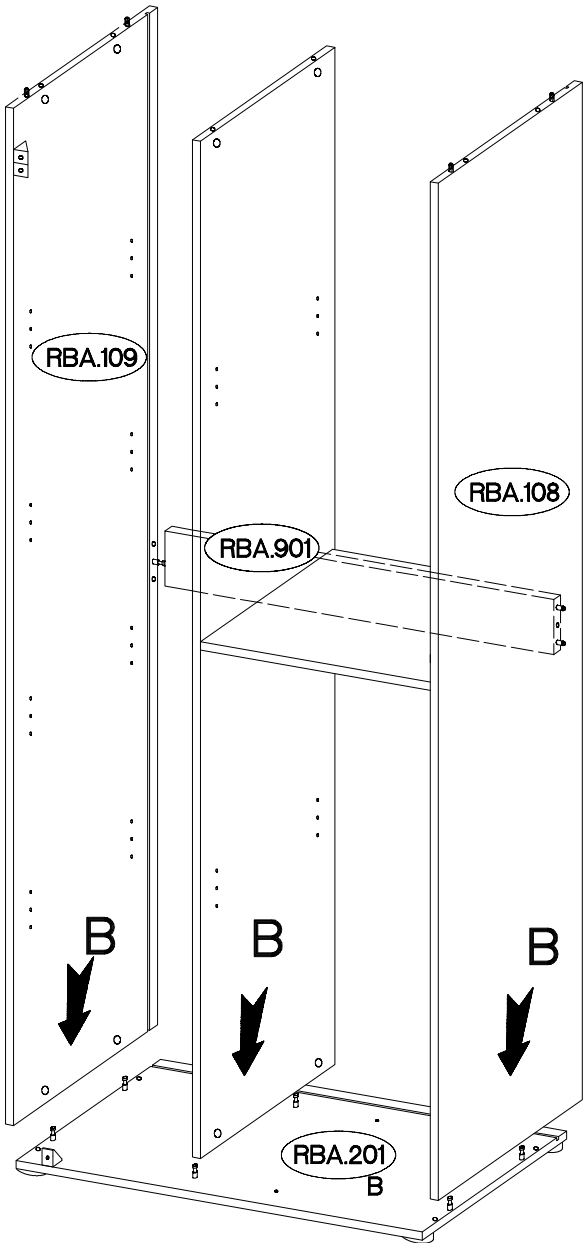

27

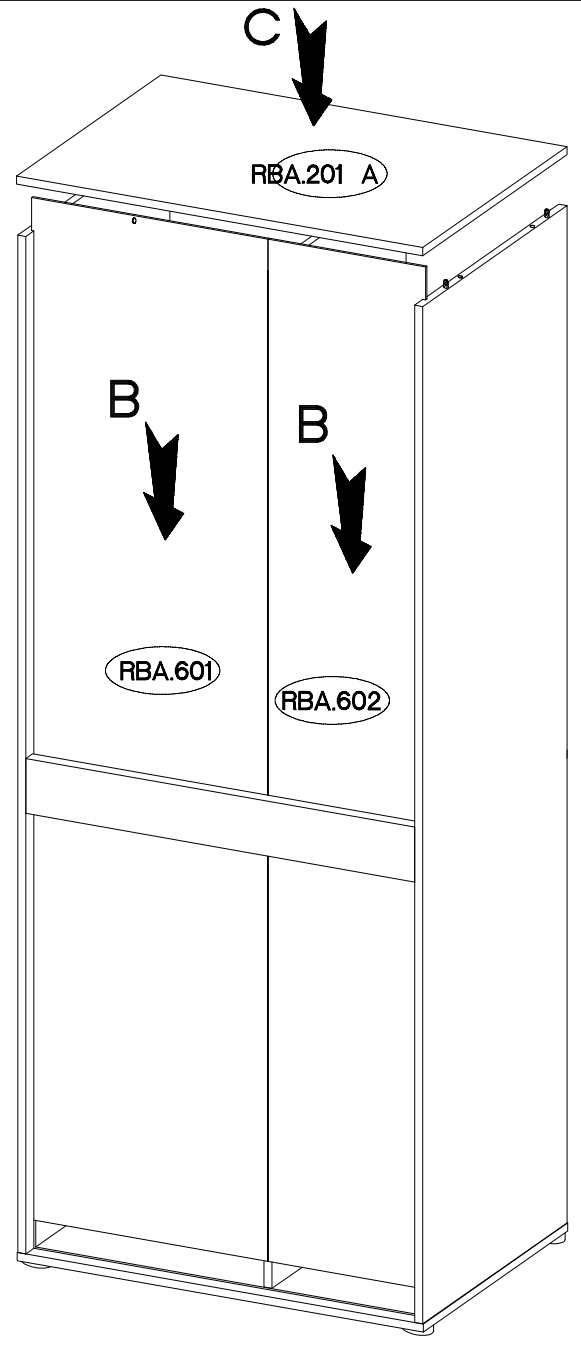
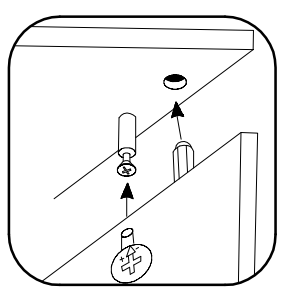
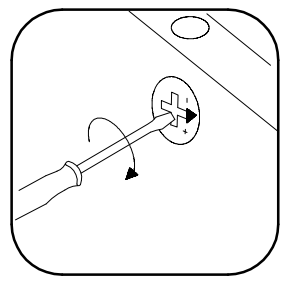
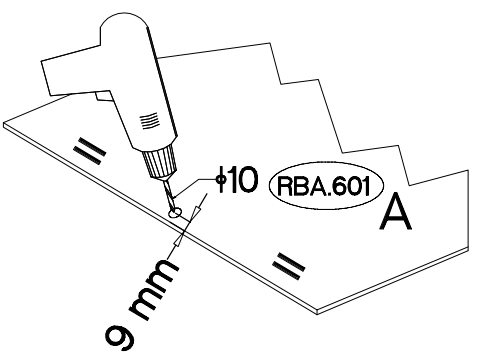

28

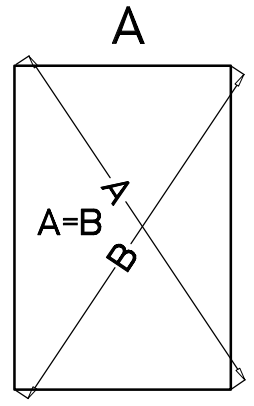
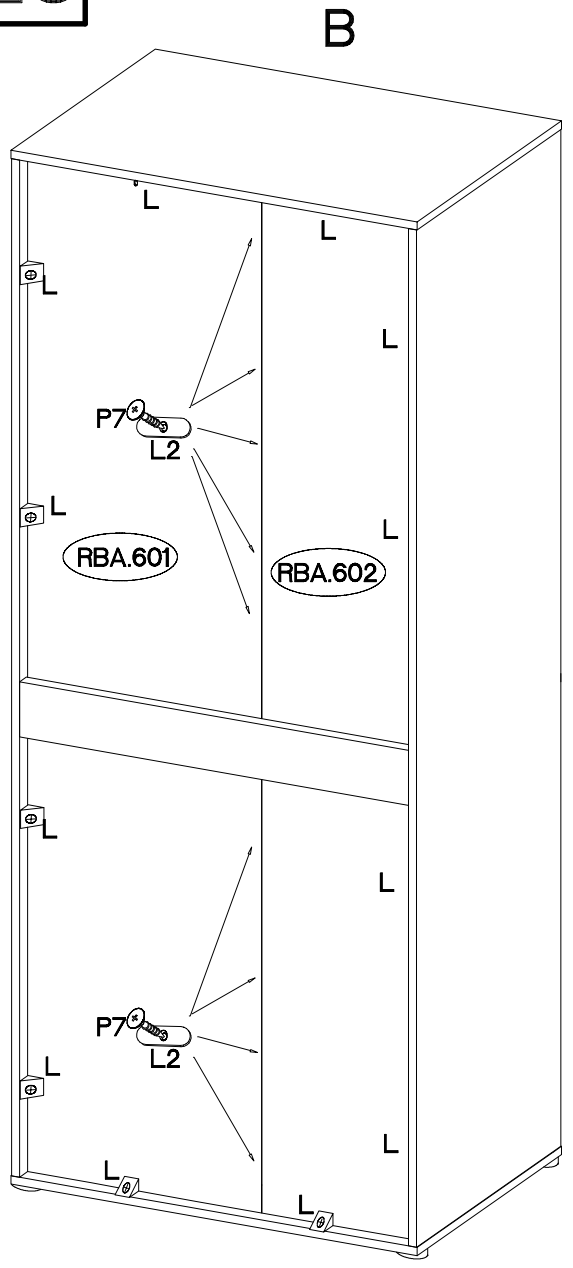

$\phi 3.0 \times 20 \text{ mm}$		
P7	L2	L
9	9	12

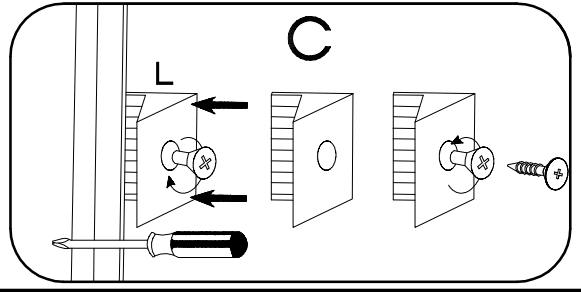
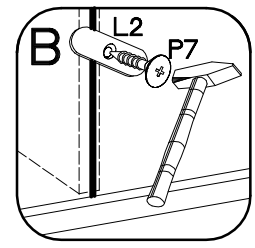
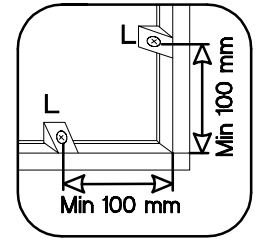

29

±4.0x16mm

P1
10

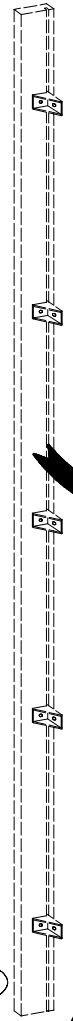
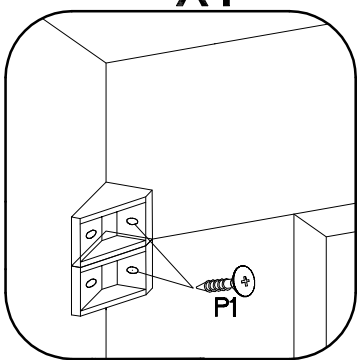
x1

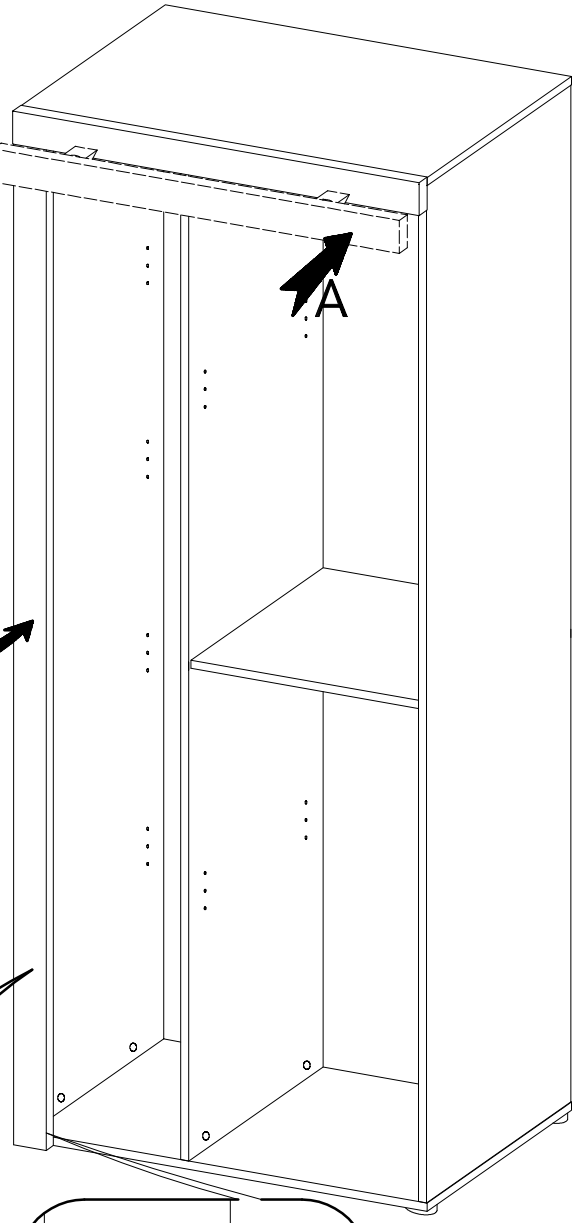

RBA.903

RBA.902



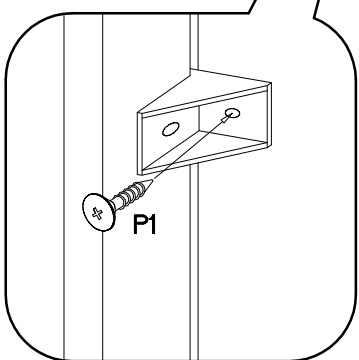

x5

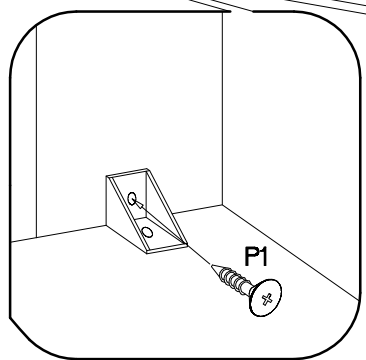

x1



30

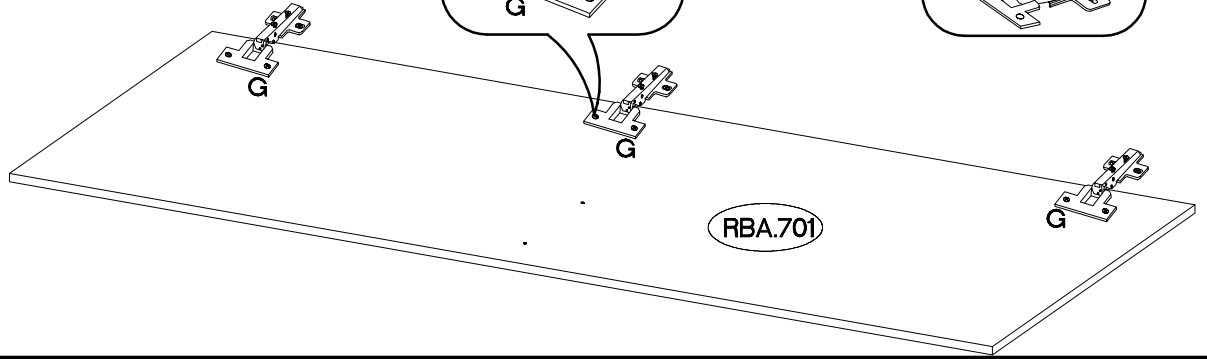
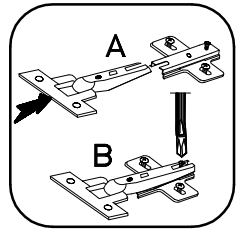
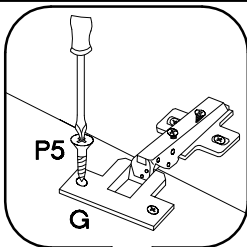

		
H=0	±35/0mm	±3.5x13mm
H	G	P5
3	3	6





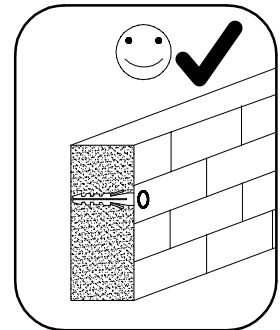
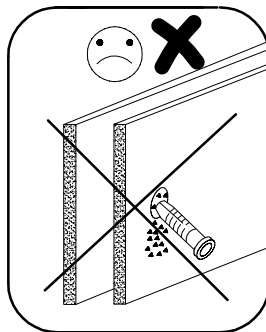
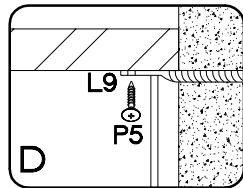
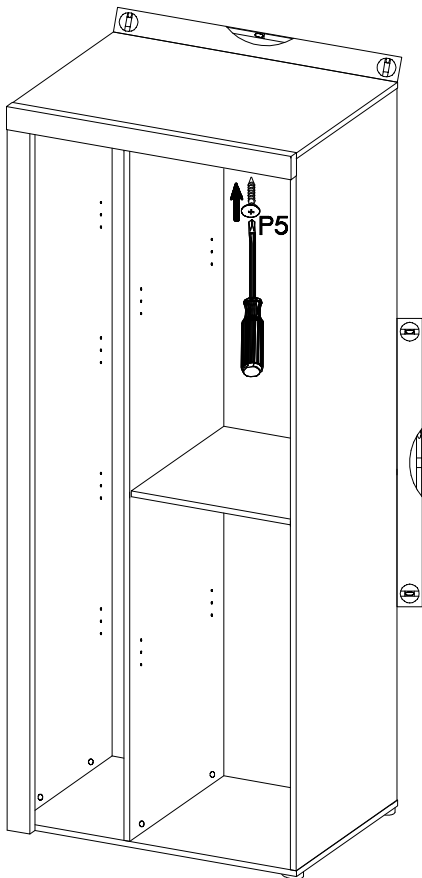
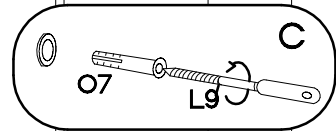
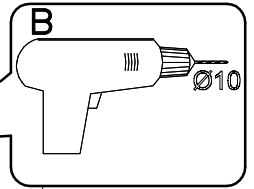
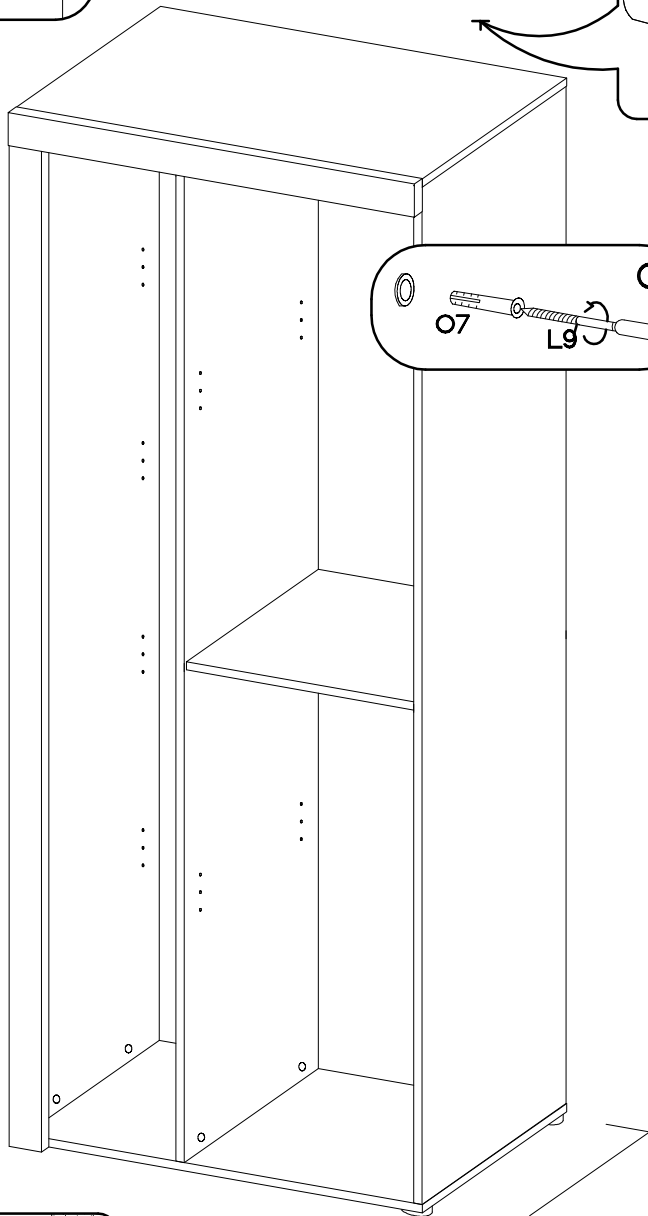
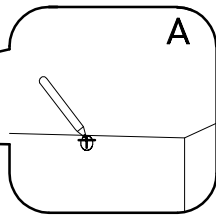
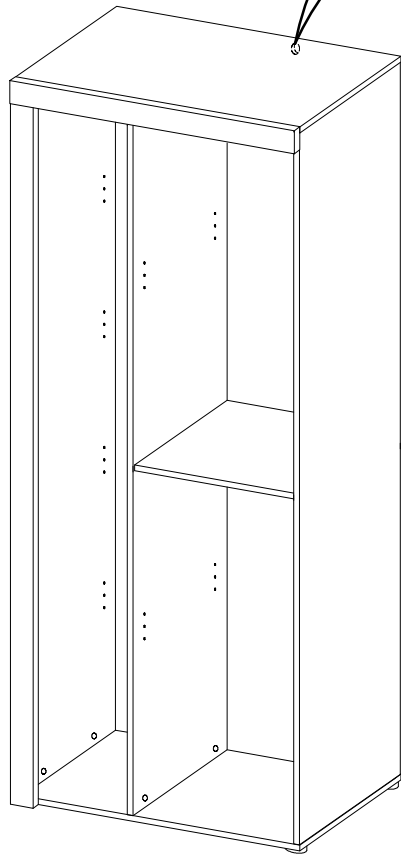

RBA.701

31



±10x50mm		±3.5x13mm
		
O7	L9	P5
1	1	1

 <b>J3</b> 8	 <b>E</b> 16	 <b>J12</b> 16	 <b>R2</b> 2	 <b>S1</b> L=128mm 1
--	--	--	--	---

