

SK NÁVOD NA MONTÁŽ
 CZ MONTÁŽNÍ NÁVOD
 HU SZERELÉSI UTASÍTÁS
 DE MONTAGEANLEITUNG

NENA SKRIŇA 2

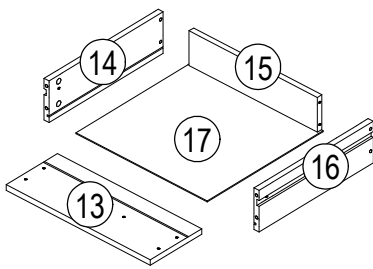

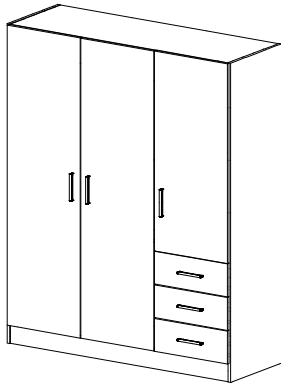

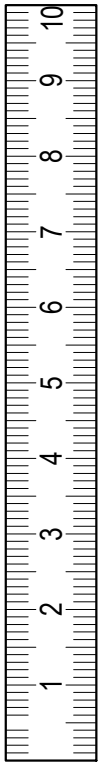
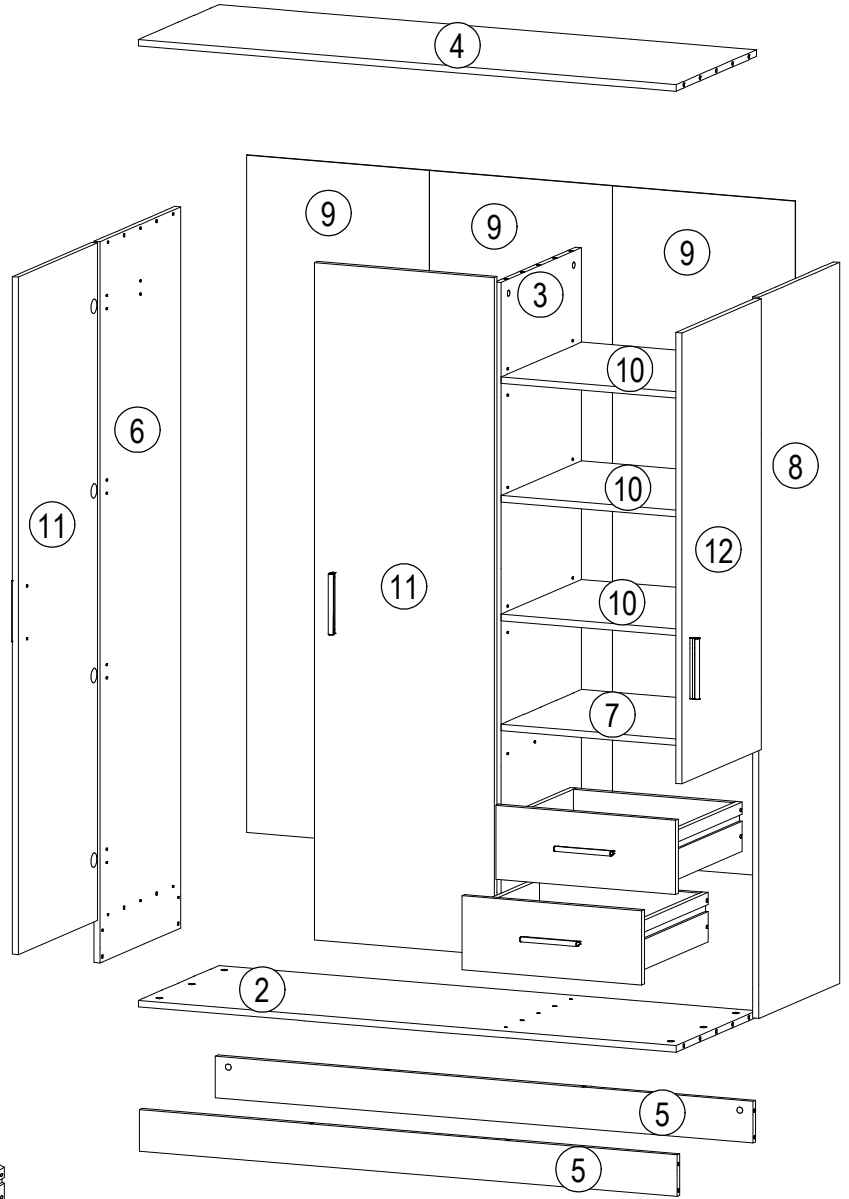





| | | |
|--|------|----|
| | 1432 | mm |
| | 1750 | |
| | 495 | |

| ID | ID | Part | Qty | Unit |
|-------|----|--------------|-----|------|
| 09218 | 2 | 1400*475*16 | 1x | 2/3 |
| 09410 | 3 | 1616*475*16 | 1x | 1/3 |
| 09411 | 4 | 1400*475*16 | 1x | 2/3 |
| 09219 | 5 | 1400*101*16 | 2x | 2/3 |
| 09209 | 6 | 1750*476*16 | 1x | 1/3 |
| 09210 | 7 | 456*474*16 | 1x | 2/3 |
| 09399 | 8 | 1750*476*16 | 1x | 1/3 |
| 09212 | 9 | 1644*476*2,5 | 3x | 1/3 |
| 09211 | 10 | 456*474*16 | 3x | 2/3 |
| 09216 | 11 | 1644*468*16 | 2x | 3/3 |
| 09217 | 12 | 1094*468*16 | 1x | 3/3 |
| 09213 | 13 | 468*180*16 | 3x | 3/3 |
| 08007 | 14 | 400*120*16 | 3x | 2/3 |
| 09214 | 15 | 416*100*16 | 3x | 2/3 |
| 08009 | 16 | 400*120*16 | 3x | 2/3 |
| 09215 | 17 | 406*426*2,5 | 3x | 2/3 |

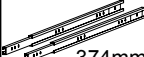

| | | | | | | | | | |
|-----------------------|-----------------------|-----------------------|--------------|-------------------------|-----------------------|------------------------|-------------------------|-------------------------|-----------------------|
| 22300,00 Ø7x50 | 22502,00 M4x12 | 27000,00 Ø8x30 | 32030,00 | 22243,00 Ø3,5x15 | 30090,00 | 70018,01 | 33018,00 374mm | 21102,00 Ø1,6x20 | 35101,01 |
| A 12x | B 6x | C 24x | D 6x | E 28x | F 8x | G 2x | H 3x | J 75x | K 12x |
| 36002,07 | 36002,07 | 34906,00 | 70013,01 | 70021,01 | 22400,00 M4x30 | 22705,00 Ø6,3x8 | 22244,01 Ø3,5x16 | 24008,00 | 70017,44 922mm |
| L 11x | M 11x | N 27x | O 40x | P 40x | R 12x | S 18x | T 12x | U 17x | V 1x |

| | | | | | | | | | |
|--|--------------|--|---------|-------|--|--------|------------|--|--|
| | | | | | | | | | |
| | | | | | | | | | |
| | 1h 40min | | PZ2 | 4 | | 3m | 600 mm | | |

| | | | | | | | | | | | | | | | | | | | |
|---|--|--|--|--|--|---|--|--|--|---|-----|---|-----|---|----|---|-----|---|-----|
|  |  |  |  |  |  |  |  |  |  | | | | | | | | | | |
| C | 4x | E | 6x | F | 4x | G | 2x | H | 3x | K | 12x | M | 11x | O | 6x | P | 22x | S | 18x |

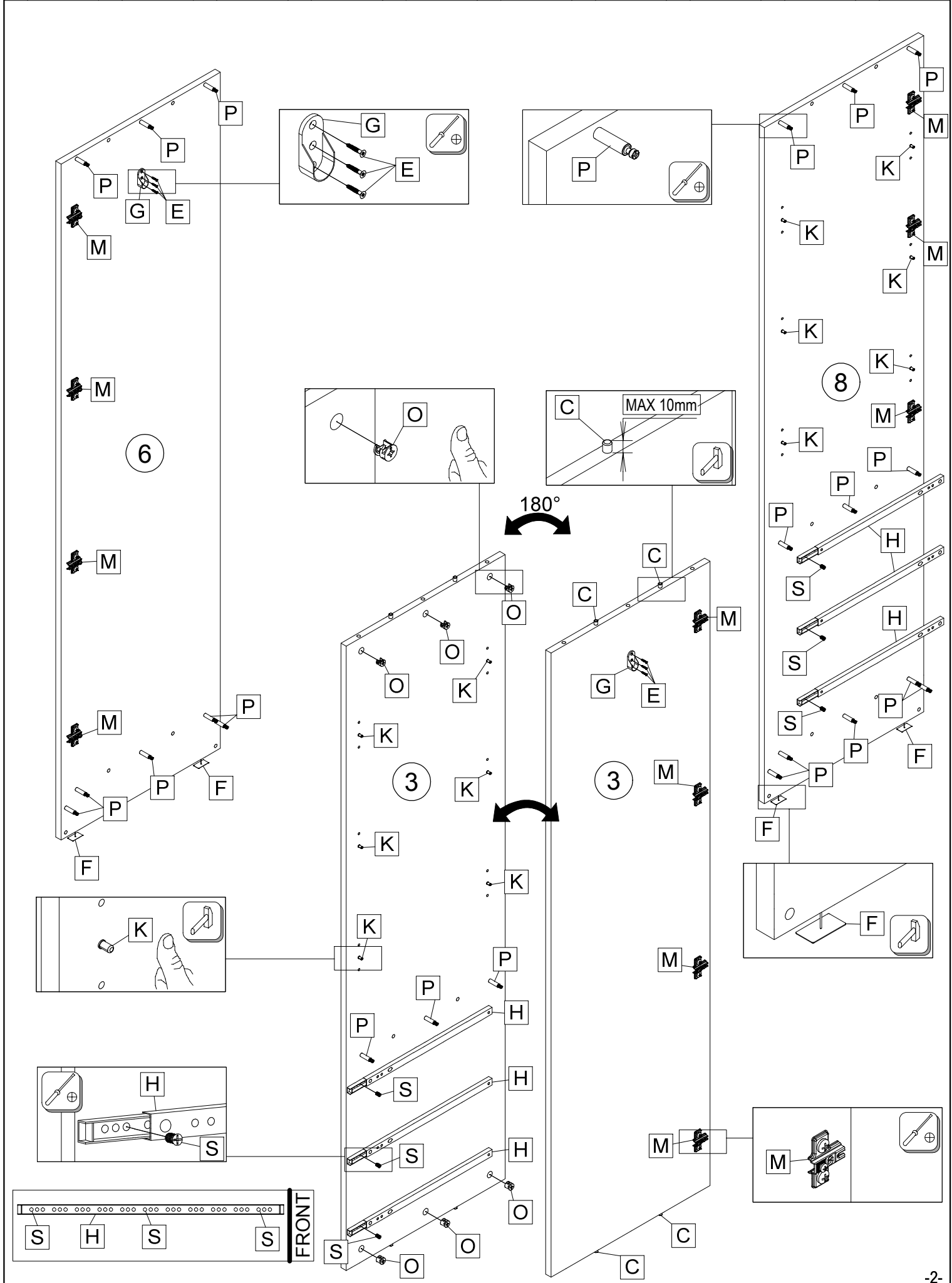

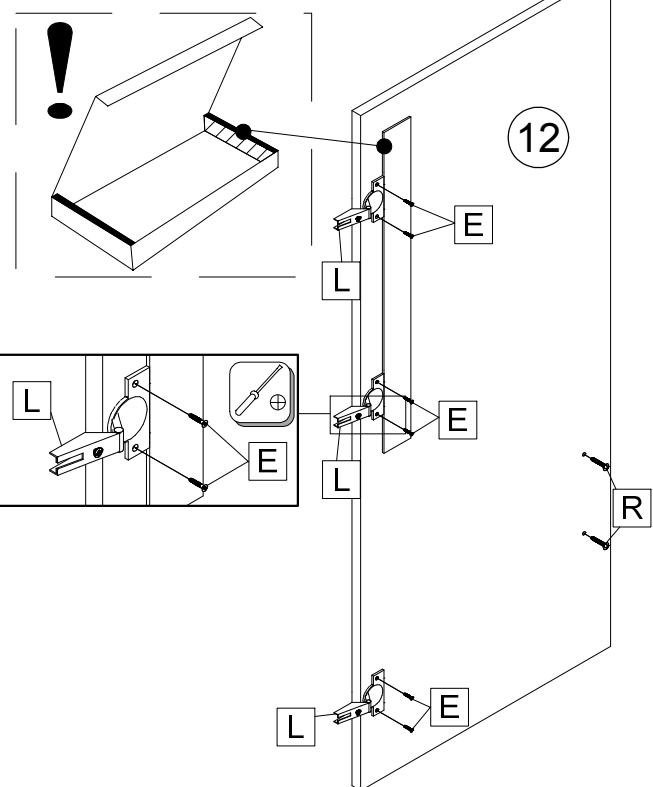
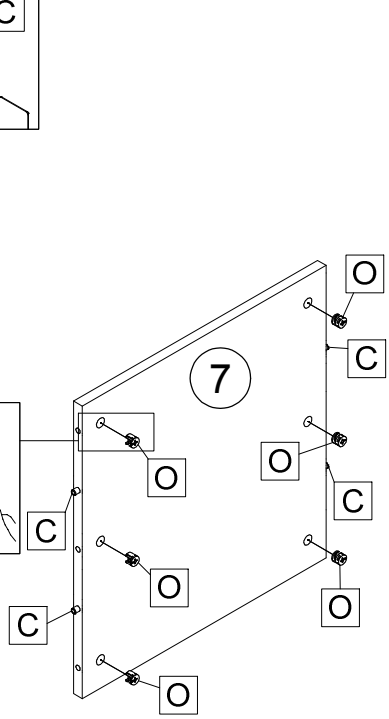
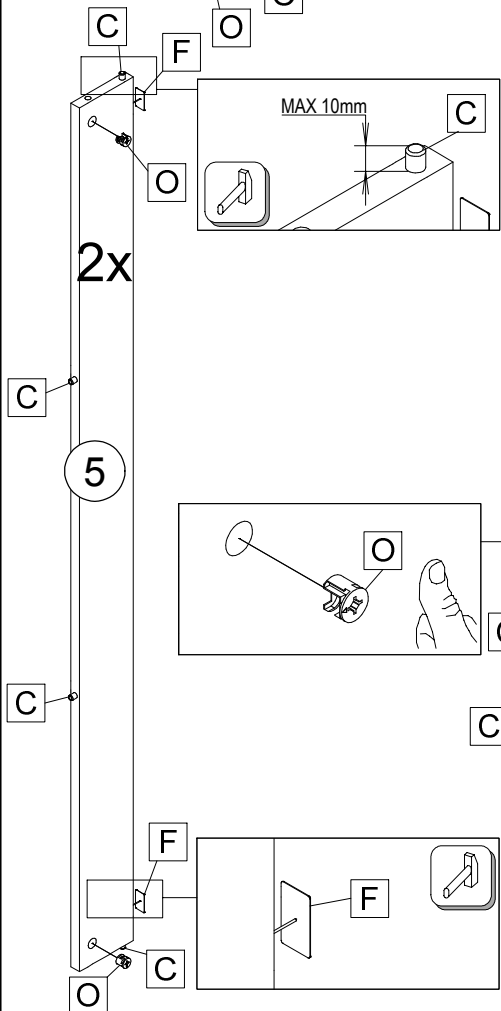
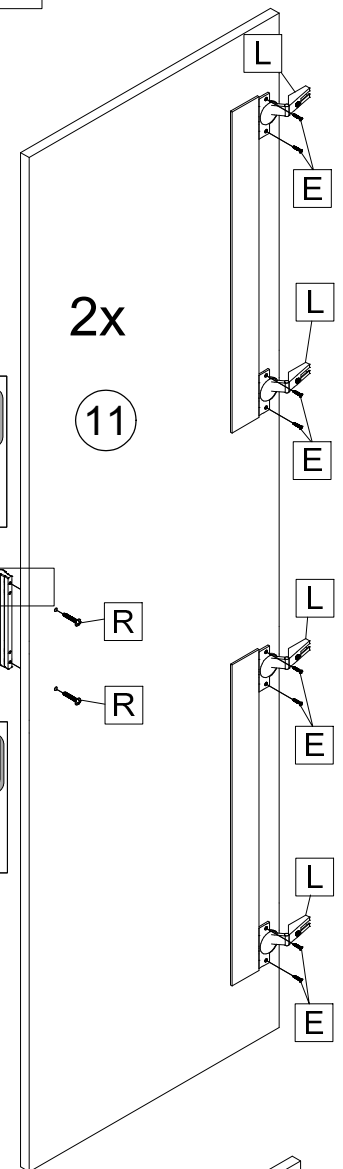
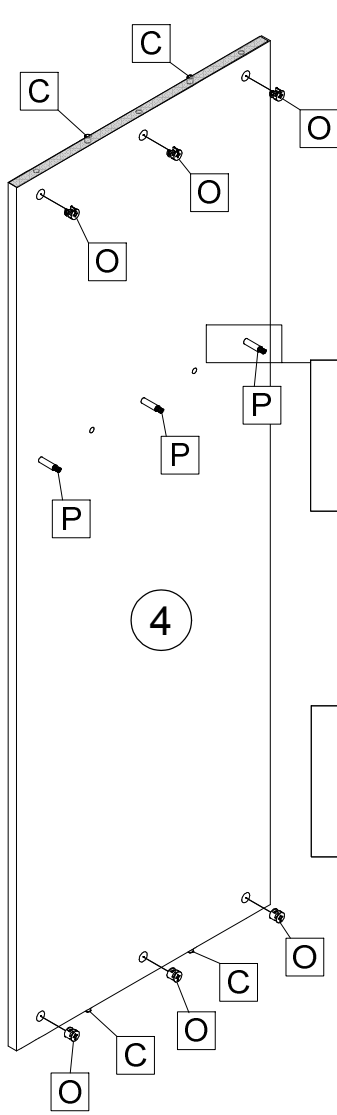
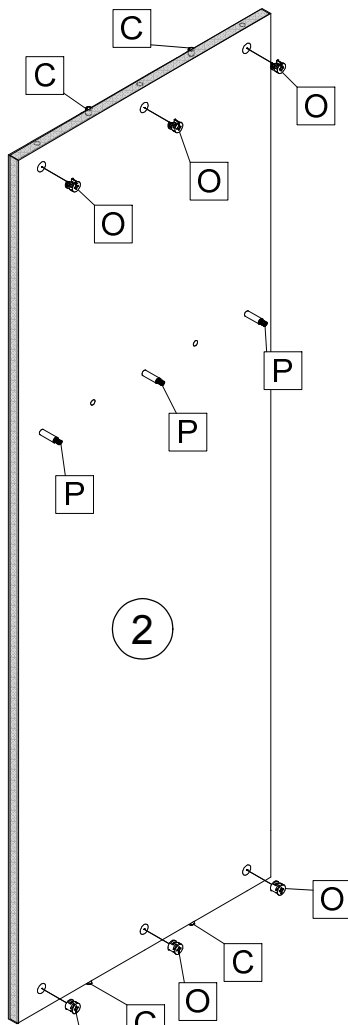

| | | | | | | | |
|-------|------|-------|------|-------|-------|------|------|
| | | | | | | | |
| C 20x | D 3x | E 22x | F 4x | L 11x | O 22x | P 6x | R 6x |

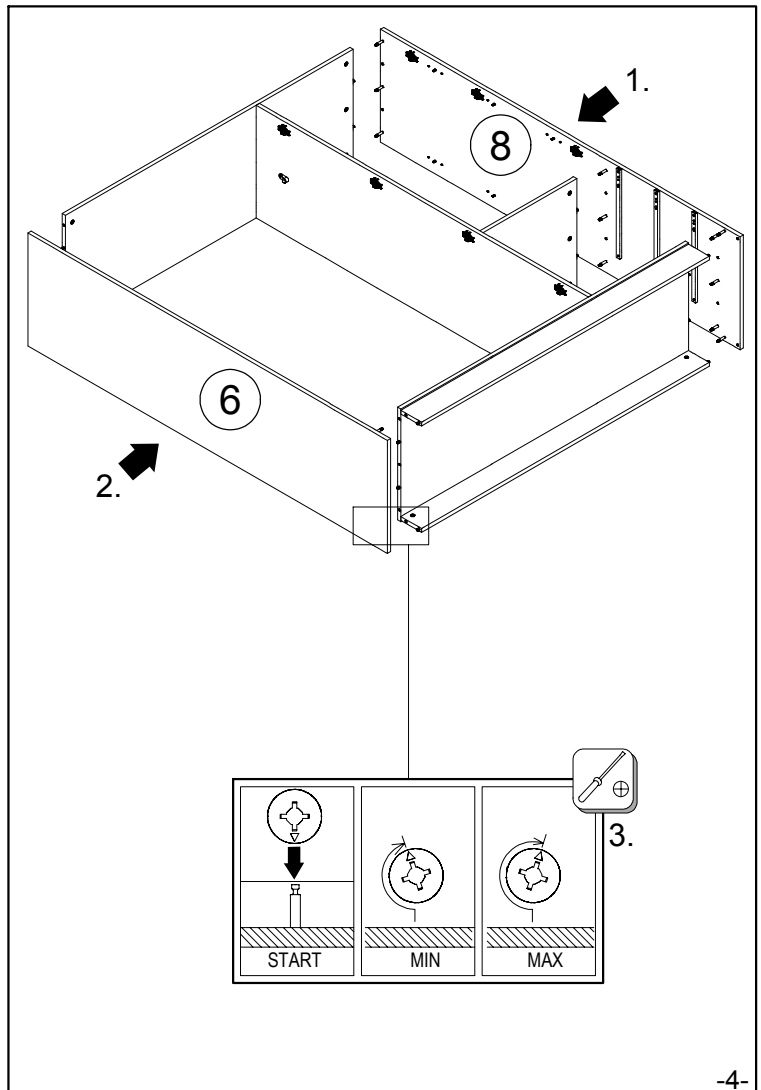
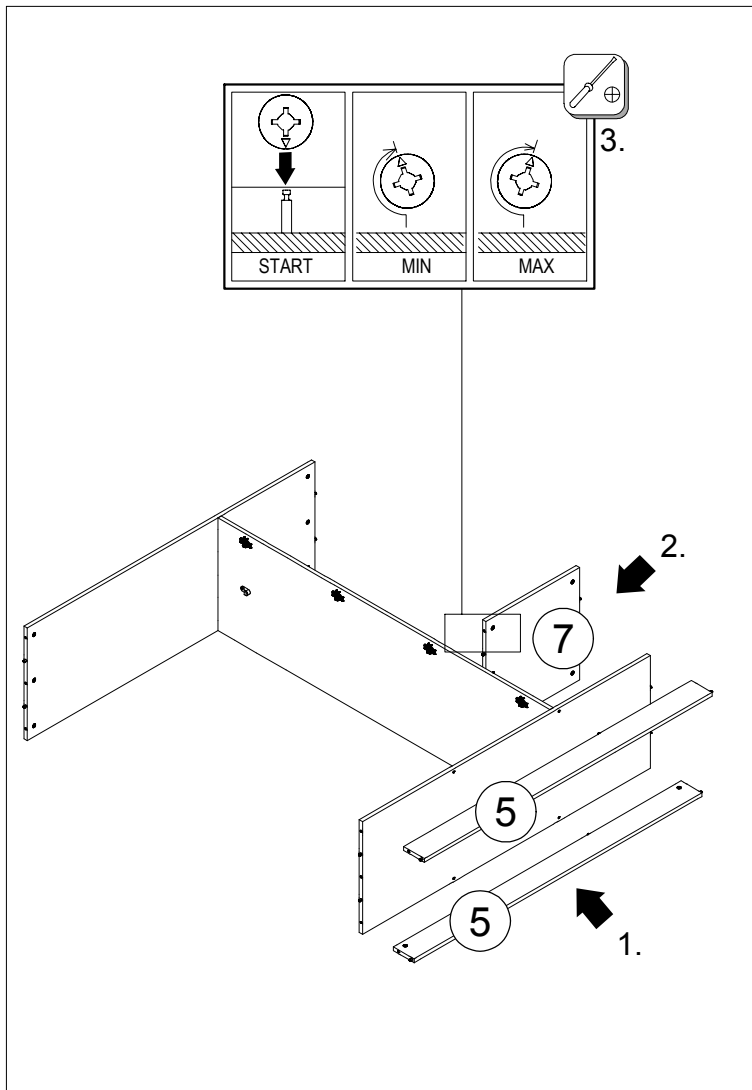
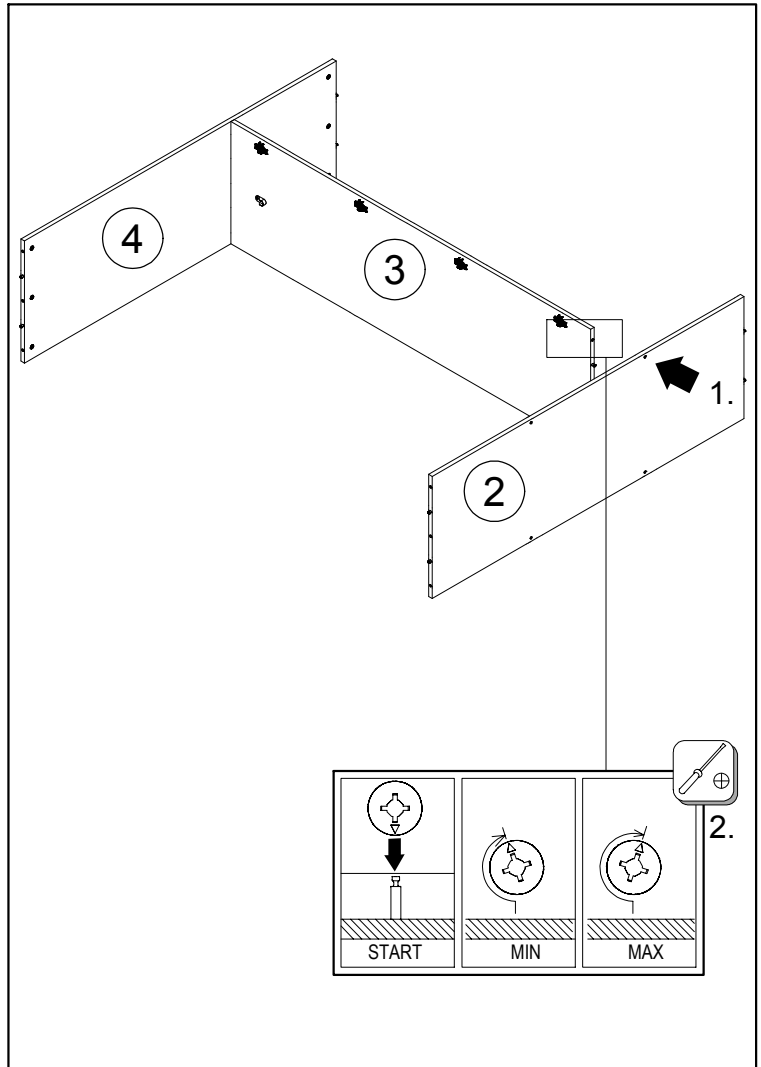
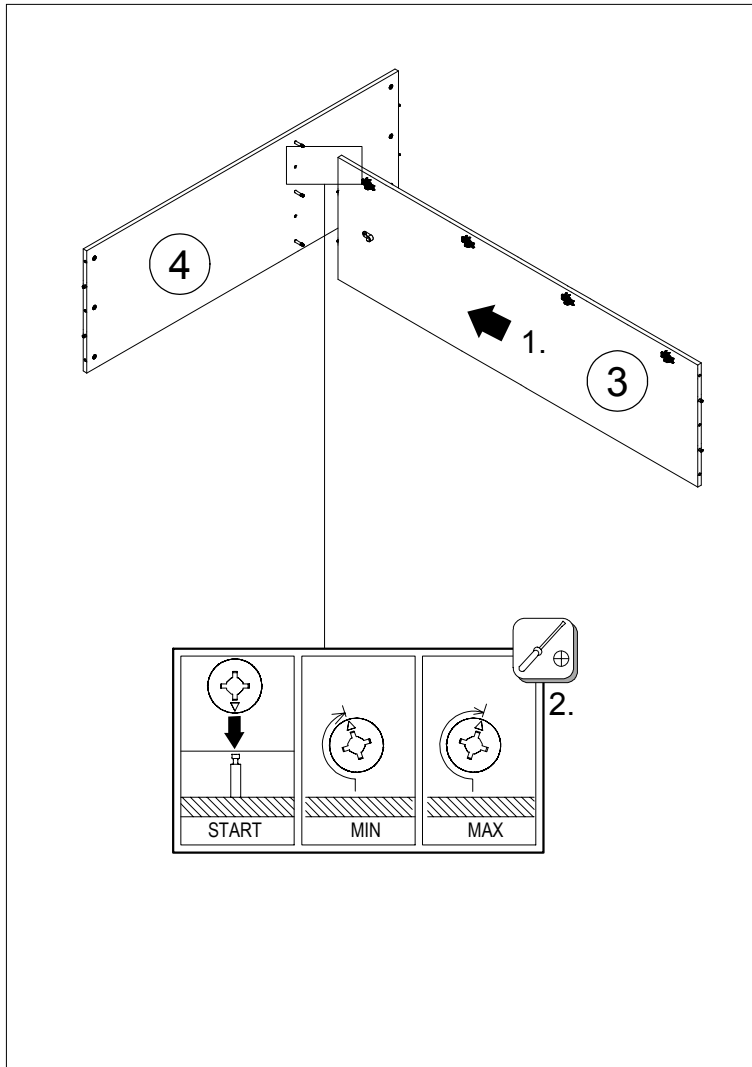

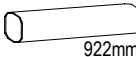

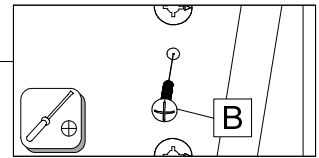
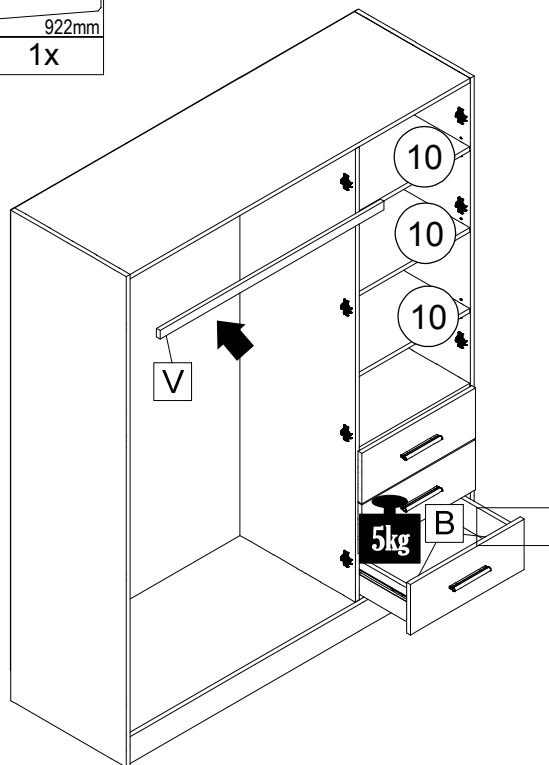
| | |
|---|--|
|  M4x12 |  922mm |
| B 6x | V 1x |



| |
|---|
|  |
| N 27x |

