

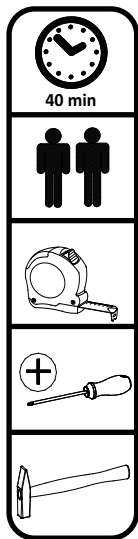

Фабрика меблів
КИЇВСЬКИЙ СТАНДАРТ

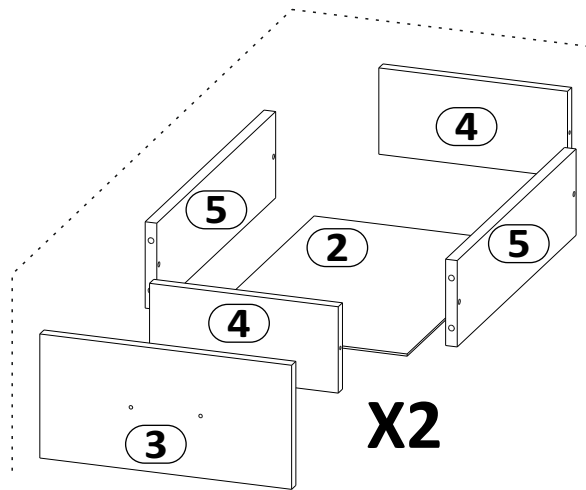

Тумба STELLA

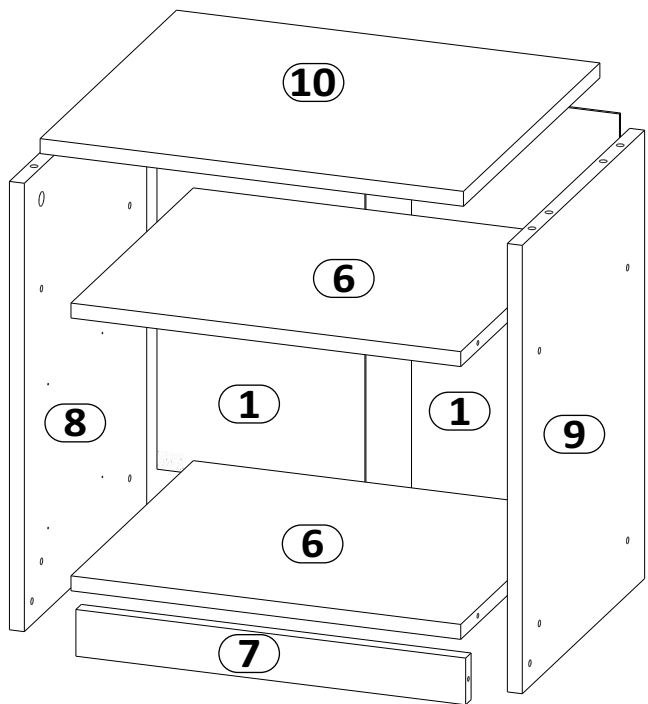

№	a*b	X
1	442x223	2
2	392x350	2
3	150x447	2
4	360x98	4
5	350x98	4
6	418x360	2
7	50x418	1
8	480x360	1
9	480x360	1
10	450x400	1

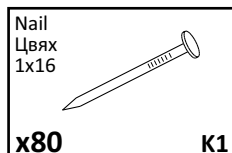
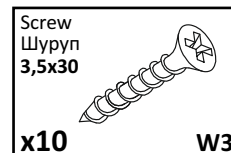
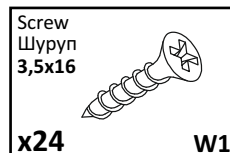
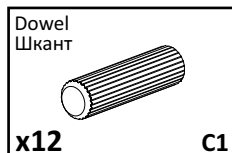
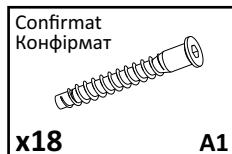



Фабрика меблів

КИЇВСЬКИЙ СТАНДАРТ

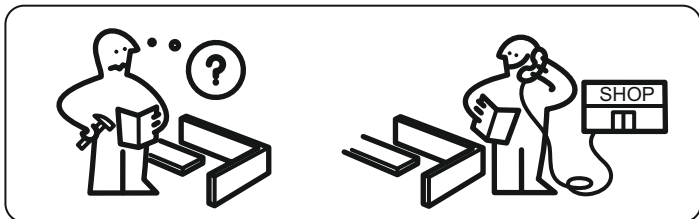
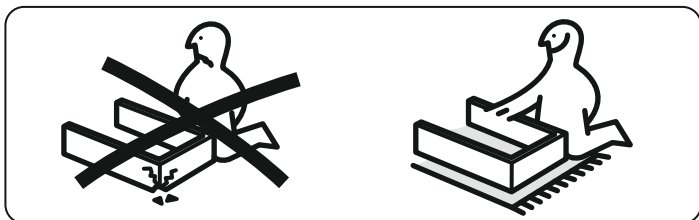
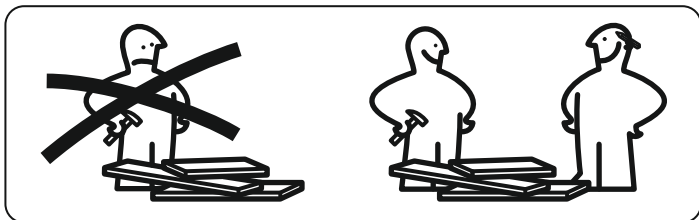

kievstandart.com

ЗАГАЛЬНІ ТЕХНІЧНІ ВКАЗІВКИ ПО ЗБИРАННЮ МЕБЛІВ

- ПЕРЕД ЗБИРАННЯМ ПЕРЕВІРТЕ КОМПЛЕКТНІСТЬ ДЕТАЛЕЙ ТА ФУРНИТУРИ.
- ДЛЯ ЗБИРАННЯ МЕБЛІВ РЕКОМЕНДУЄМО СКОРИСТАТИСЬ ПОСЛУГАМИ КВАЛІФІКОВАНИХ СПЕЦІАЛІСТІВ.
- ДЛЯ ЗАПОБІГАННЯ ПОДРЯПИН ВИКОНУЙТЕ ЗБИРАННЯ НА ПОВЕРХНІ, ЯКА НАКРИТА ТКАНИНОЮ АБО КАРТОНОМ.

ПРАВИЛА ДОГЛЯДУ ТА ЕКСПЛУАТАЦІЇ

- БЕРЕЖІТЬ МЕБЛІ ВІД ДОВГОГО КОНТАКТУ З ВОДОЮ ЧИ З ГАРЯЧОЮ ПАРОЮ.
- ЗАБЕЗПЕЧТЕ ДОСТАТНЮ ВІДСТАНЬ ВІД ЕЛЕКТРИЧНИХ ПРИЛАДІВ ТА ОБІГРІВАЧІВ.
- У РАЗІ ПОЯВИ БРУДУ НА МЕБЛЯХ ВИДАЛЯЙТЕ ЙОГО ВОЛОГОЮ ТКАНИНОЮ ІЗ НАСТУПНИМ ВИТИРАННЯМ НАСУХО. НЕ ВИКОРИСТОВУЙТЕ АБРАЗІВНІ МАТЕРІАЛИ.

GENERAL TECHNICAL INSTRUCTIONS FOR FURNITURE ASSEMBLY

- CHECK COMPATIBILITY OF PARTS AND ACCESSORIES BEFORE ASSEMBLY.
- FOR FURNITURE ASSEMBLY, WE RECOMMEND USING THE SERVICES OF QUALIFIED SPECIALISTS.
- DO ASSEMBLY ON A SURFACE COVERED WITH CLOTH OR CARDBOARD TO PREVENT SCRATCHES.

CARE AND MAINTENANCE OF FURNITURE

- KEEP THE FURNITURE FROM PROLONGED CONTACT WITH WATER OR HOT STEAM.
- ENSURE SUFFICIENT DISTANCE FROM ELECTRICAL APPLIANCES AND HEATERS.
- IF THERE IS DIRTY ON THE FURNITURE, REMOVE IT WITH A DAMP CLOTH AND THEN WIPE IT DRY. DO NOT USE ABRASIVE MATERIALS.

1

Telescopic Guide
Напр. Біла.
350 мм

x2**NR 1/2**

Eccentric Minifix
Екцентрик

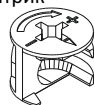
x4**M1**

Screw
Шуруп
3,5x16

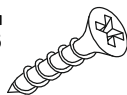
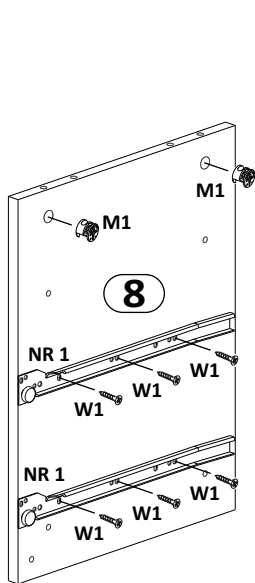
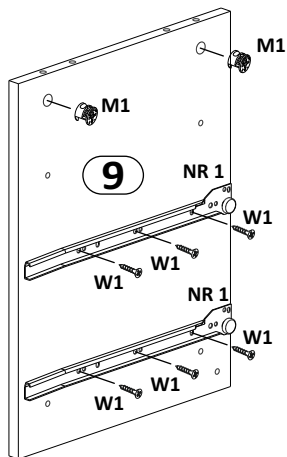
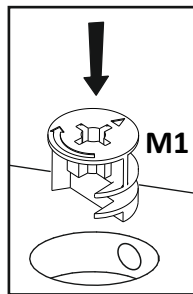
x12**W1****8****9****5****2**

Minifix Screw
Болт стяжки Мініфікс

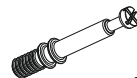
x4**M2**

Dowel
Шкант

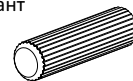
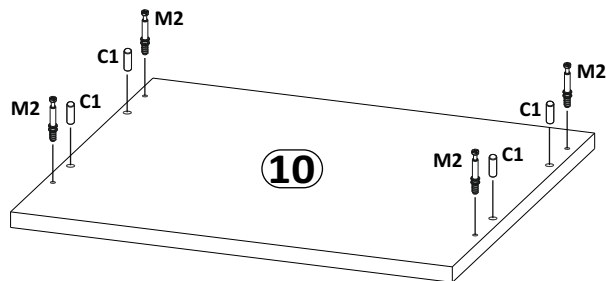
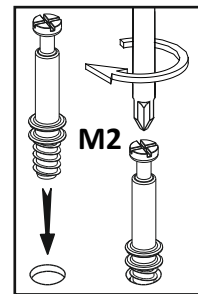
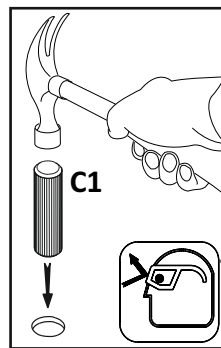
x4**C1****10**

3

Confirmat
Конфірмат

**x10****A1**

Cap for confirmate
Заглушки для конфірмата

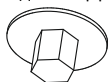
**x10****A2**

Confirmation Key
Ключ конфірматний

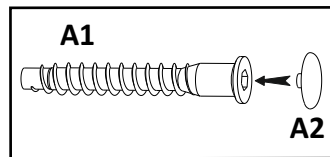
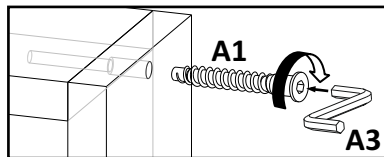
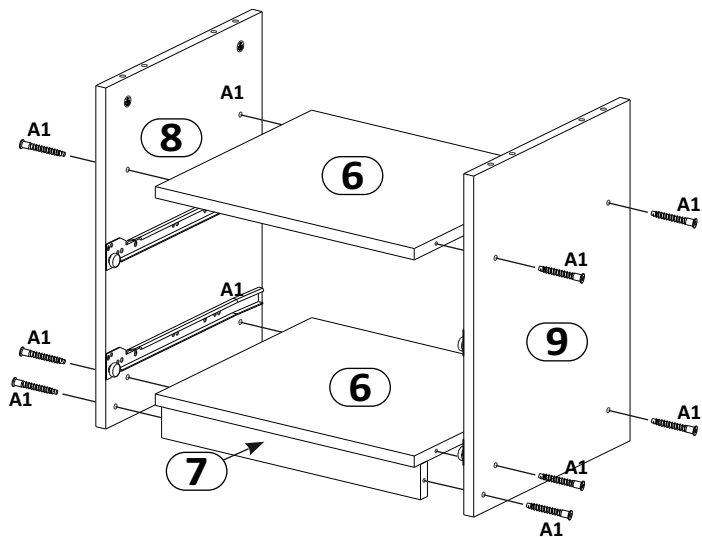
**x1****A3****4**

Support-lining
Цвях опора

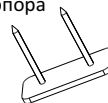
**x4****Q3**

Cap for Minifix
Заглушка на Мініфікс

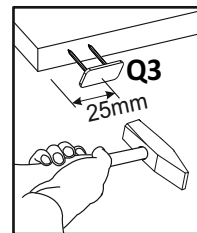
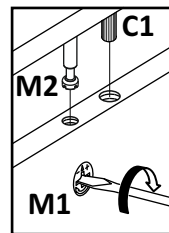
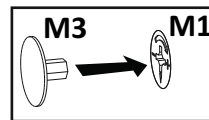
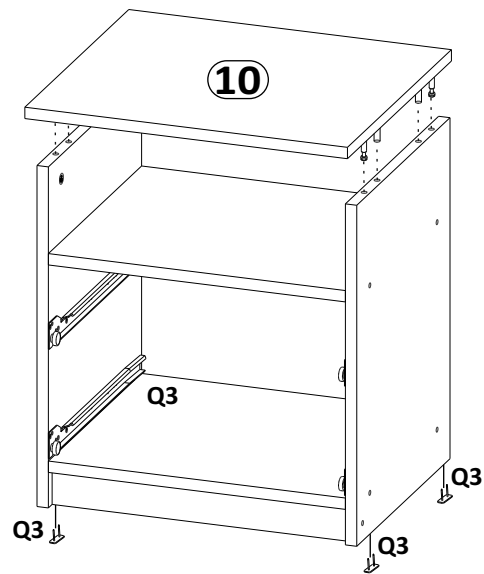
**x4****M3**

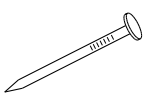
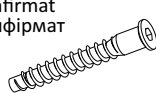
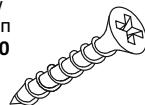
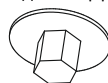
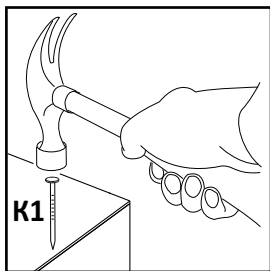
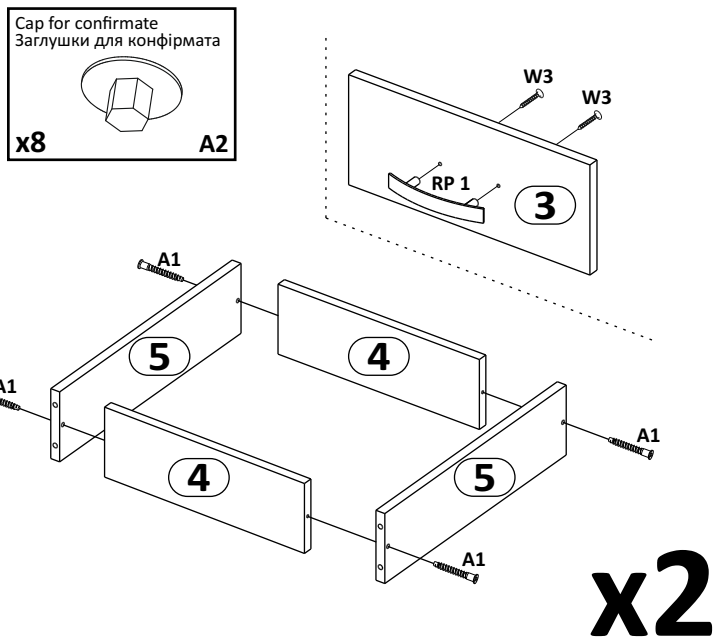
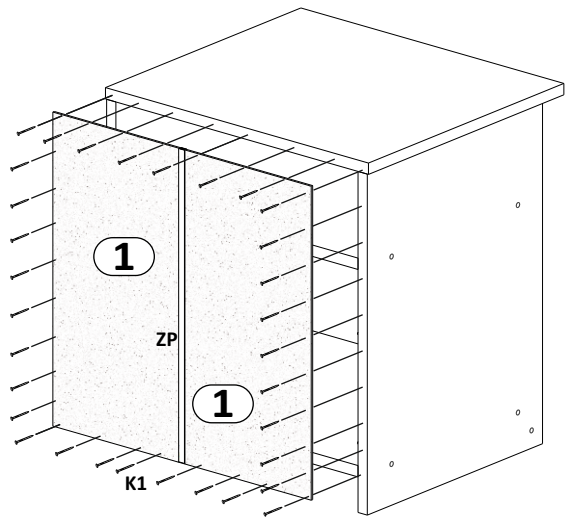
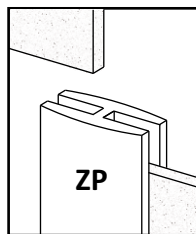
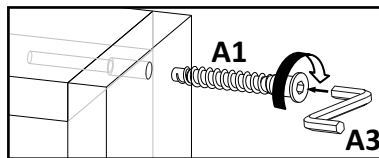
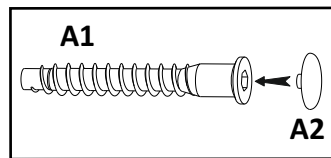
5Nail
Цвях
1x16**x50****K1**Joining Strip
З'єднувальна Планка**x1****ZP****6**Conformat
Конфірмат**x8****A1**Screw
Шуруп
3,5x30**x4****W3**Plastic Handle
Ручка пластик
96 мм**x2****RP 1**Cap for conformate
Заглушки для конфірмата**x8****A2****K1****ZP****A1****A2****A1****A2**

7

Nail
Цвях
1x16

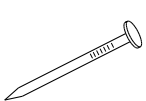
**x30****K1**

Dowel
Шкант

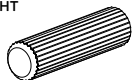
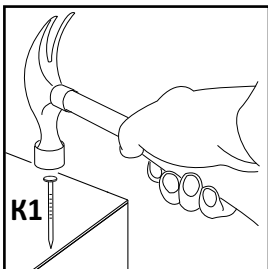
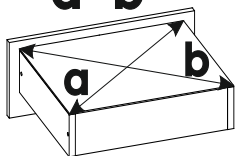
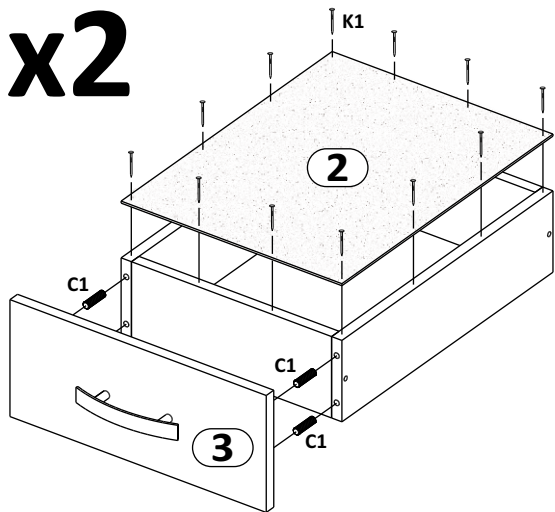
**x8****C1****K1****a=b****x2****8**

Telescopic Guide
Напр. Біла.
350 мм

**x2****NR 1/2**

Screw
Шуруп
3,5x16

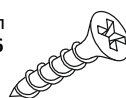
**x12****W1**

Screw
Шуруп
3,5x30

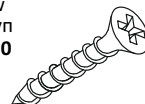
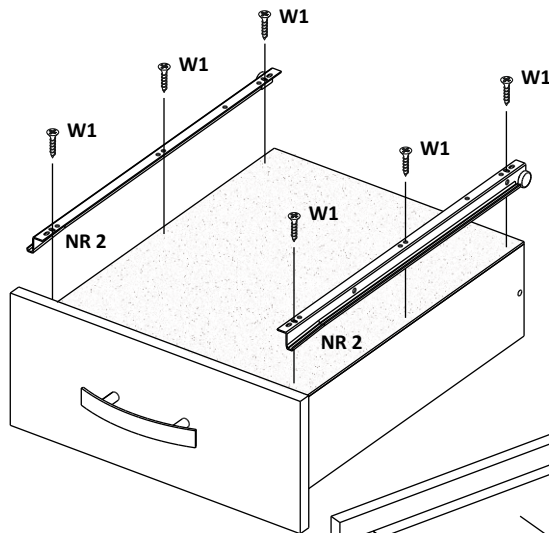
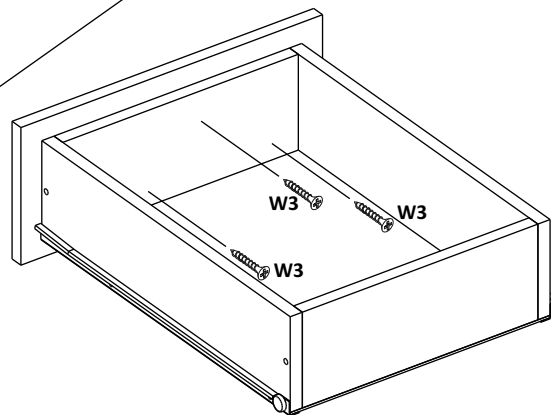
**x6****W3****x2**

9

