

PO RAO

# ASSEMBLY INSTRUCTION FOR 1.6-B41-SNS-KD

- Note
- Read instructions carefully.
  - Carefully identify each component especially those that are similar.
  - Separate and identify each component from the hardware pack and rest each one in its proper location before fastening.
  - Do not over tighten the screws or bolts when assembling.



**CAUTION**  
REFER THIS ASSEMBLY  
INSTRUCTION FOR  
ASSEMBLE

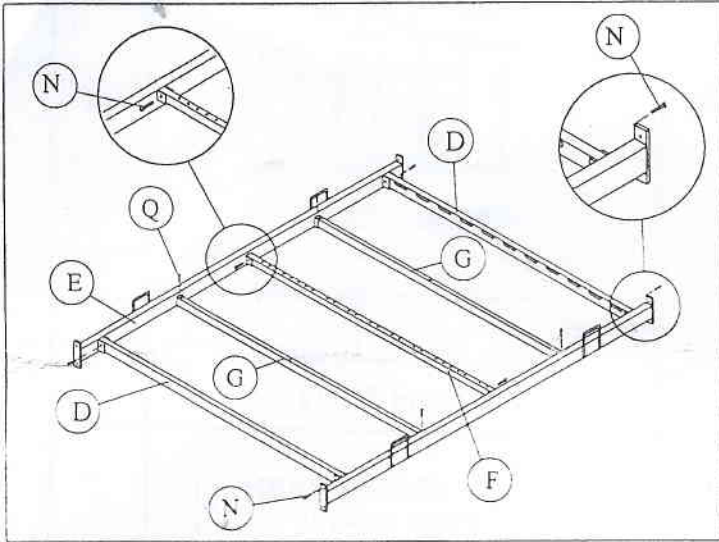

**Step 1** Fix both side rails E and cross bar F with bolt N as above diagram. Put cross bar G into side rail and fix in bolt Q. After that put end cross bar D to the end of side rail and tighten with bolt N.

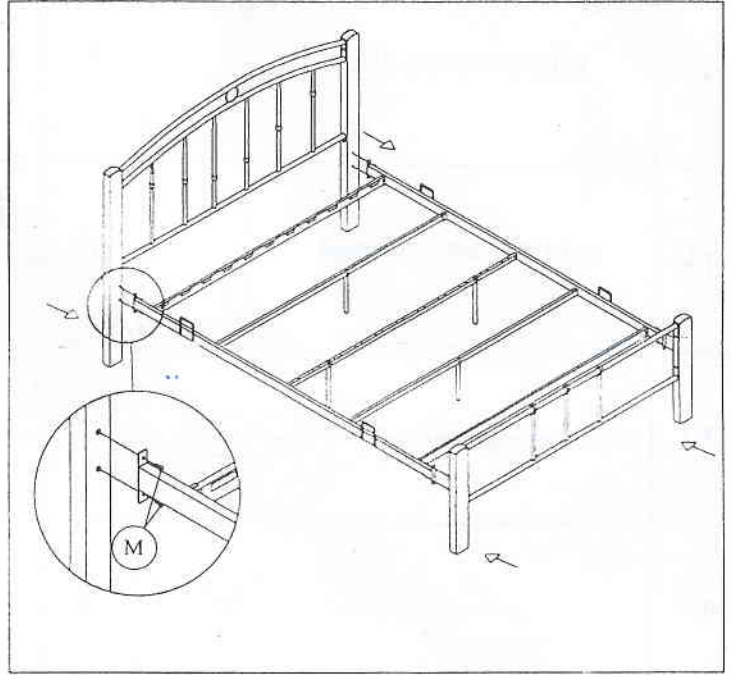

**Step 4** Assemble bed base into bed frame and tighten all bolts.

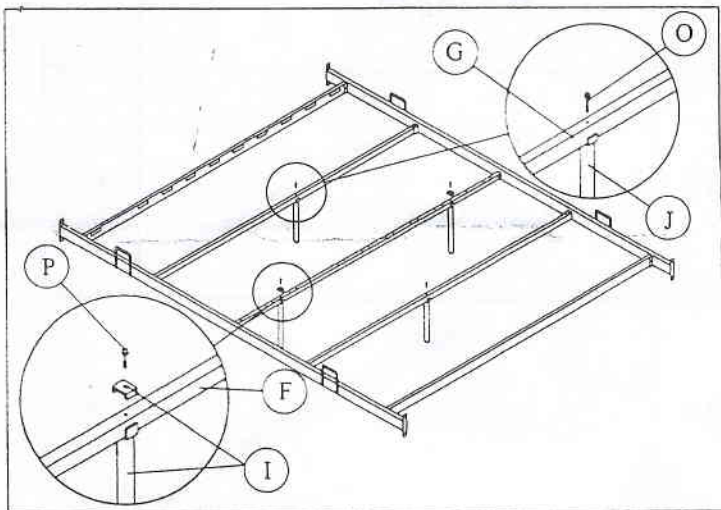

**Step 2** Fix bed support legs as shown on the picture.

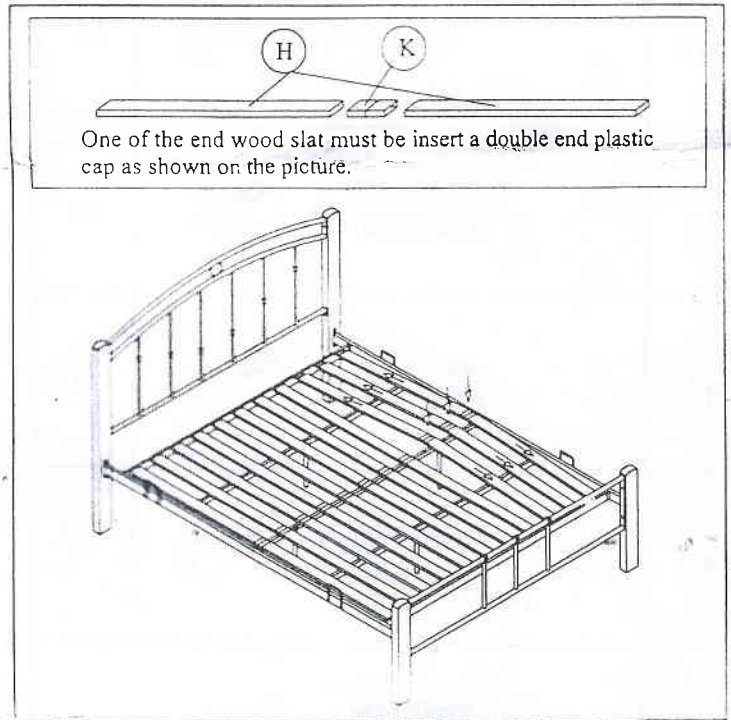



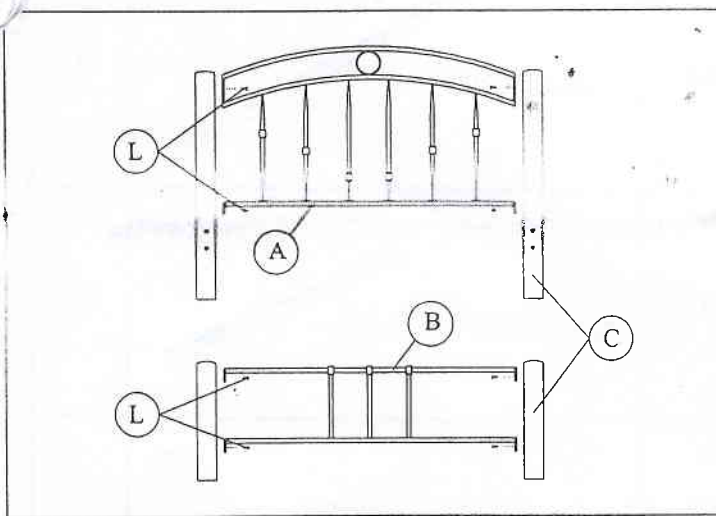







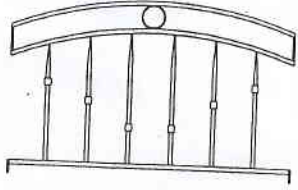

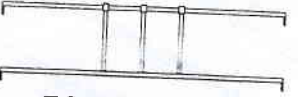



**Step 5** Once wood slats have been inserted into the plastic caps, fix one end of wood slat into the hole of end cross bar D and the other end to the other end center cross bar. After that fix the plastic cap to the center cross bar by pressing it accordingly to the default holes. Ensure the plastic cap's pin aimed to the hole.

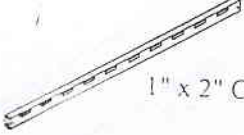

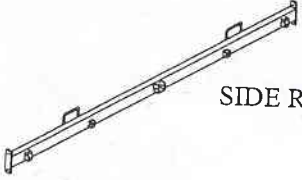
**Step 3** Fix bed frame and wood post with hardware as shown.

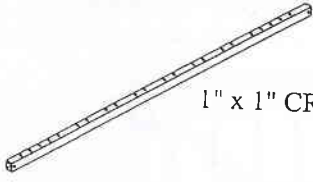
Please follow our Assembly Instruction procedure for easier assemble.

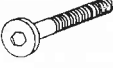
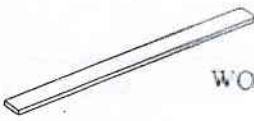
# PARTS & HARDWARE LIST FOR 1.6-B41-SNS-KD

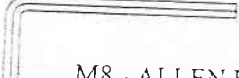
NO	PART	QTY	NO	PART	QTY
A	 HEAD FRAME	1 pc	I	 LONG SUPPORT LEG	2 pcs
			J	 SHORT SUPPORT LEG	2 pcs
B	 FOOT FRAME	1 pc	K	 Double end plastic cap	10 pcs
C	 HEAD FRAME WOOD POST	2 pcs	L	 M6x25mm	8 pcs
	 FOOT FRAME WOOD POST	2 pcs	M	 M8x25mm	8 pcs
D	 1" x 2" CROSS BAR	2 pcs	N	 M6x40mm (assembled)	6 pcs
E	 SIDE RAIL	2 pcs	O	 M6x45mm (assembled)	2 pcs
F	 1" x 1" CROSS BAR	1 pc	P	 M8x40mm (assembled)	2 pcs
G	 1/2" x 1/2" CROSS BAR	2 pcs	Q	 M6x50mm (assembled)	4 pcs
H	 WOOD SLAT	20 pcs		 M6 - ALLEN KEY	1 pc
				 M8 - ALLEN KEY	1 pc