

Richi

Комод 1200 1Д4Ш | Комод 1200 1Д4Ш Chest of Drawers 1200 1D4S

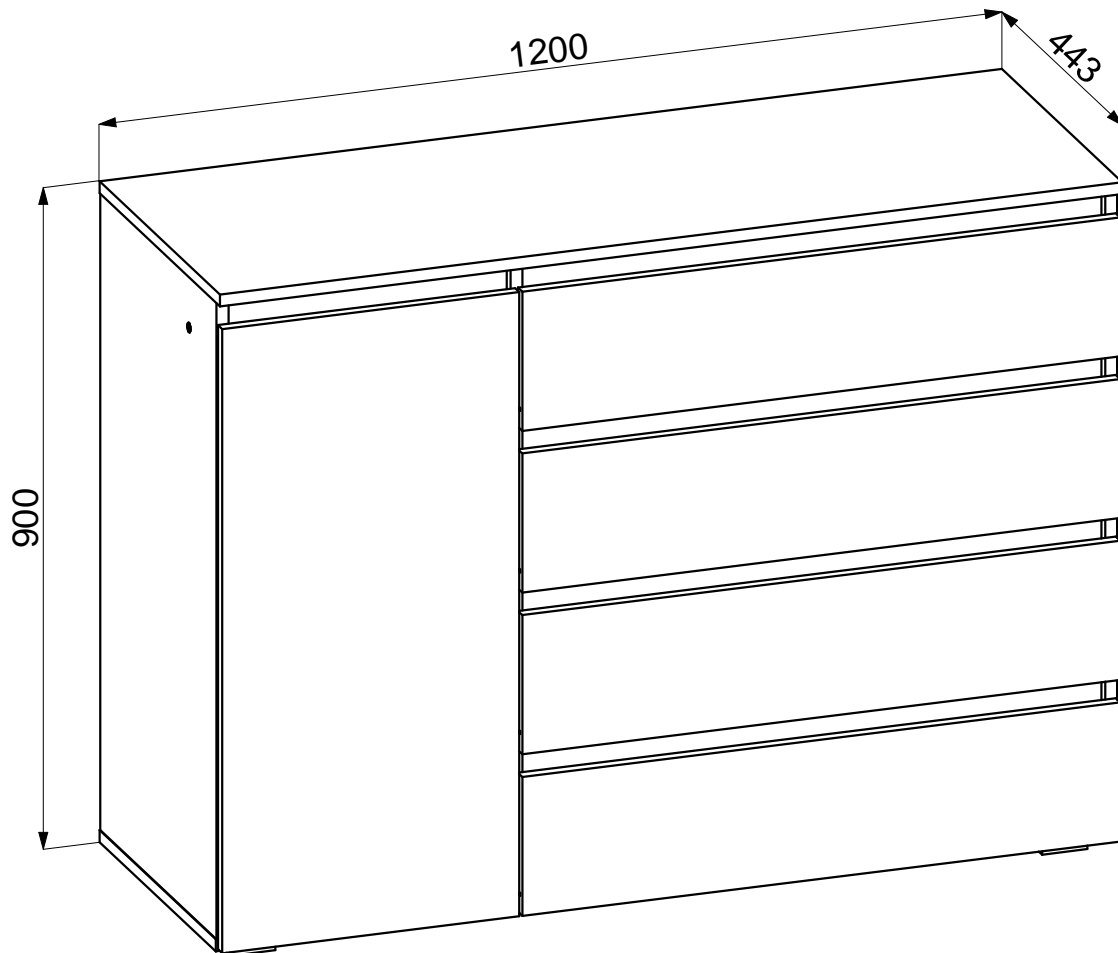











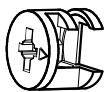
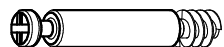

CMF Group
formula of style

Комод | Комод | Consoles

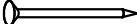
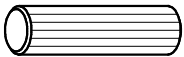
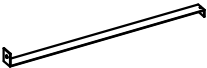
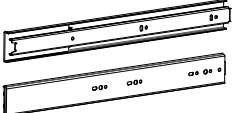

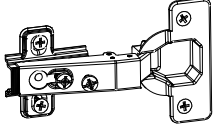
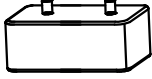
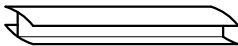
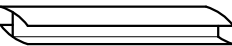

 Ø6,3x50 mm A1 x 48	 Ø12 mm A2 x 48	 4 mm A3 x 1	 Ø15x12 mm B1 x 14	 Ø5x44 mm B2 x 14
 Ø20 mm B3 x 14	 Ø12x3 mm C x 4	 Ø4x16 mm D1 x 64	 Ø3x25 mm D2 x 7	 Ø4x20 mm D3 x 4
 Ø1,6x25 mm F x 174	 Ø8x36 mm G x 41	 I x 4	 K x 4	 Ø5x16 mm L x 8
 M x 2	 N x 5	 422 mm O1 x 1	 342 mm O2 x 1	 Z x 7

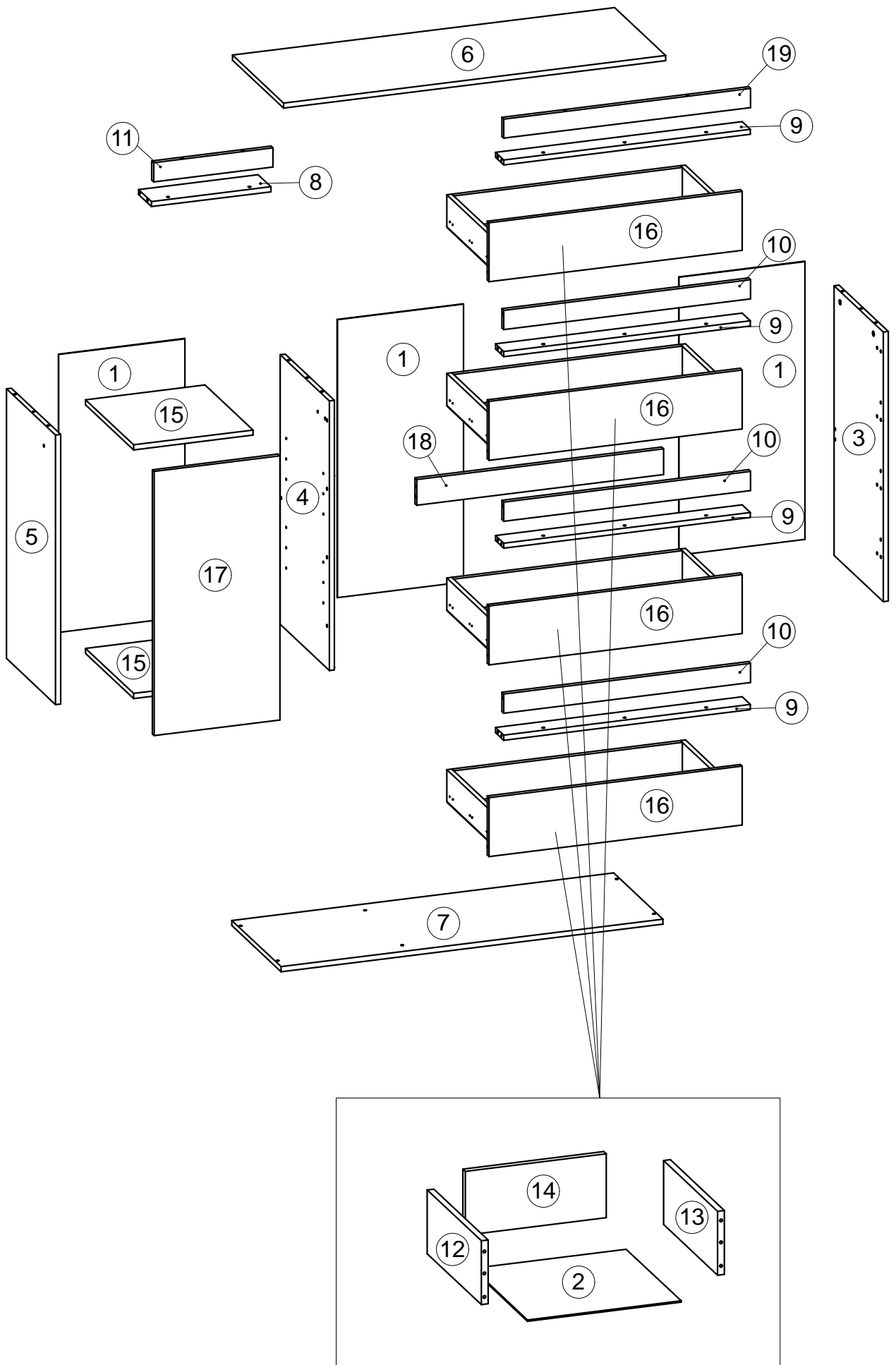

Box 1

847x424x16 mm

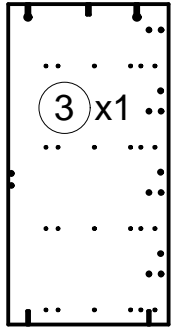

847x424x16 mm

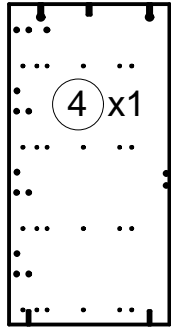

847x424x16 mm

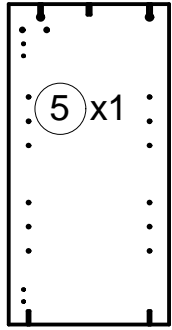

375x110x16 mm

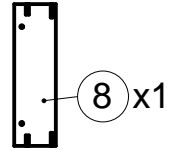

775x70x16 mm

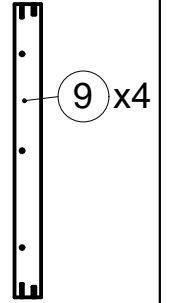

400x100x16 mm

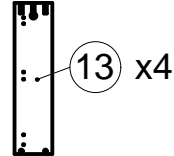

775x60x16 mm

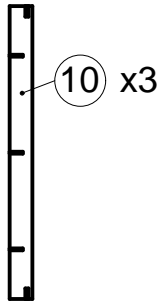

375x60x16 mm

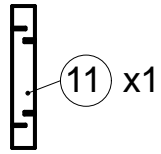

775x80x16 mm

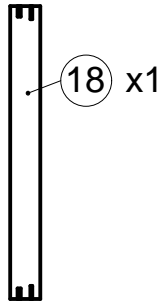

775x60x16 mm

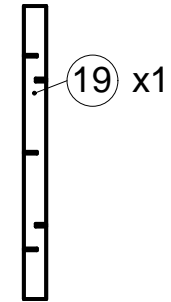

718x100x16 mm

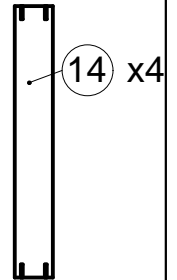

400x100x16 mm

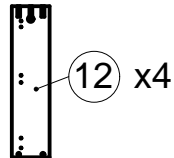

Fittings & Tools

Box 2

414x375x16 mm

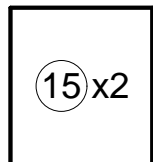

794x184x16 mm

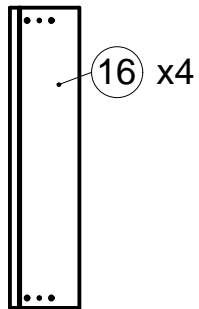

394x829x16 mm

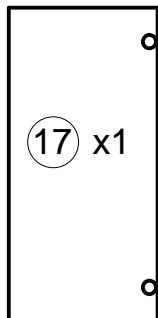

Box 3

1199x440x16 mm

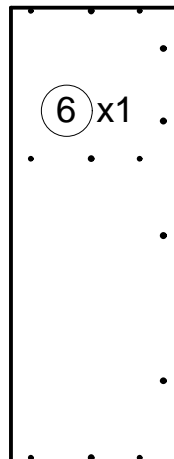

1199x424x16 mm

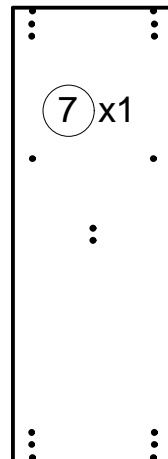

873x396x3 mm

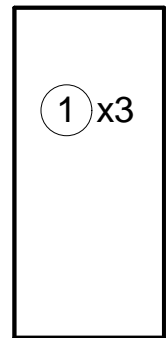

748x406x3 mm

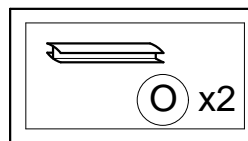
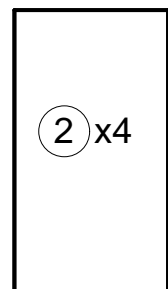

1



B1 x 2



G x 8

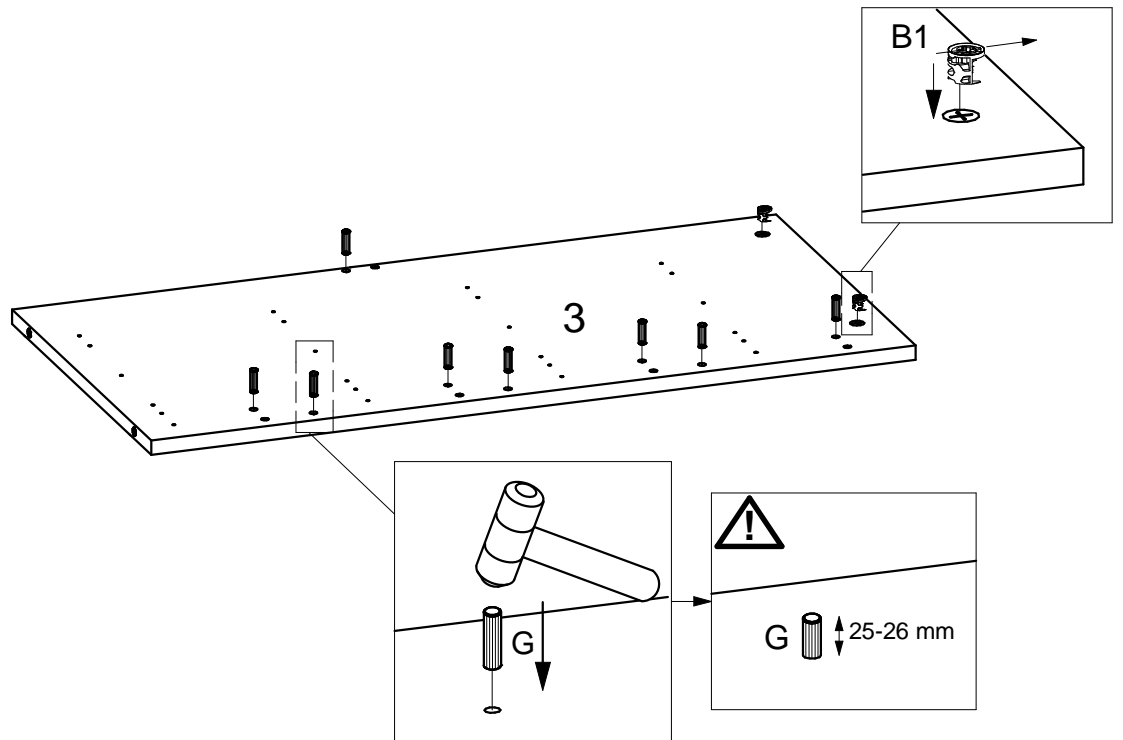
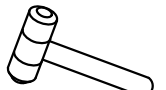
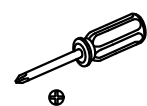

2



B1 x 2



D1 x 4



G x 1



L x 4



M.1 x 2

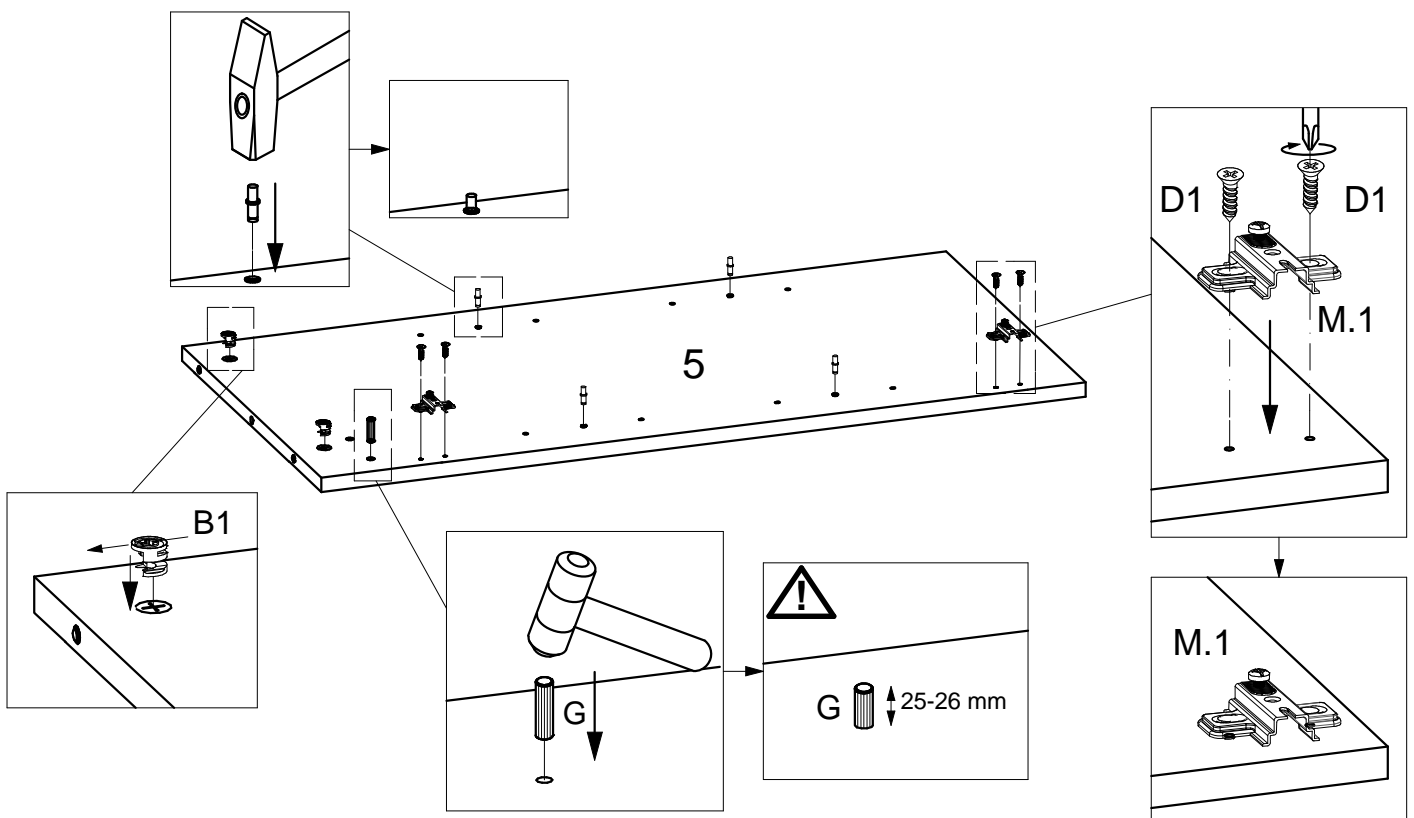
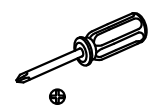
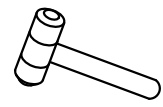
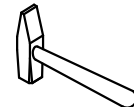

3

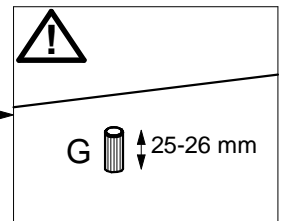
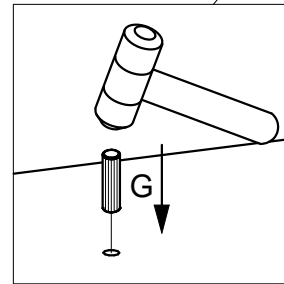
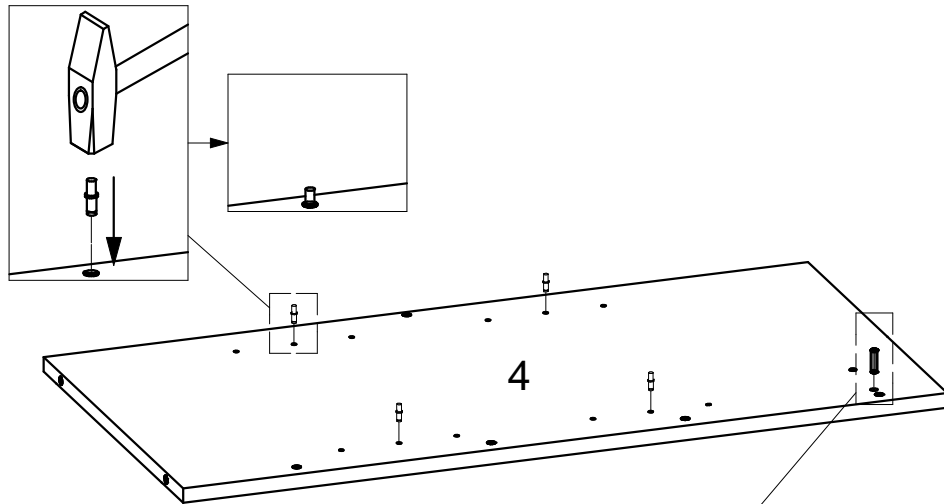
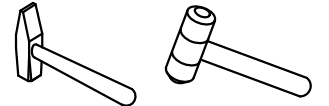
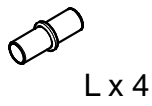
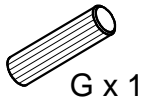

4

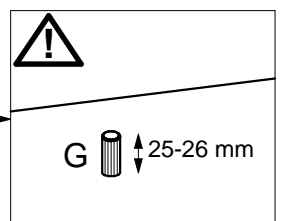
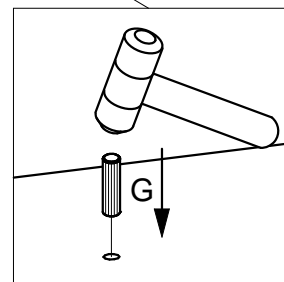
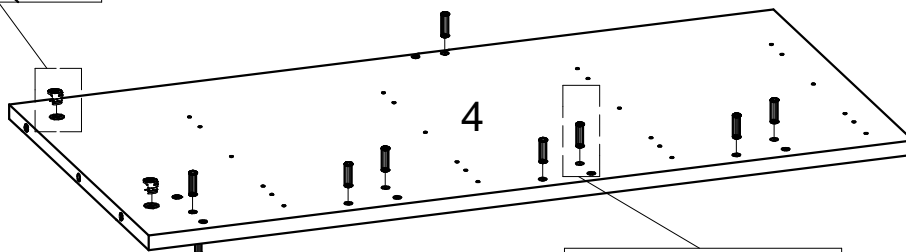
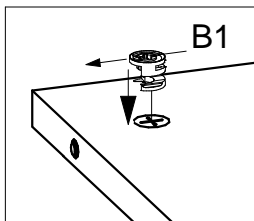
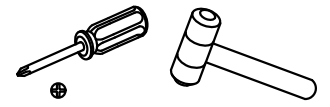
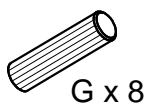
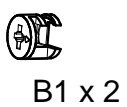

5

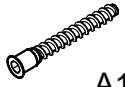

A1 x 2



A2 x 2



A3 x 1

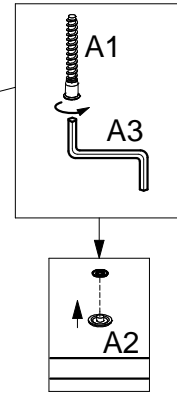
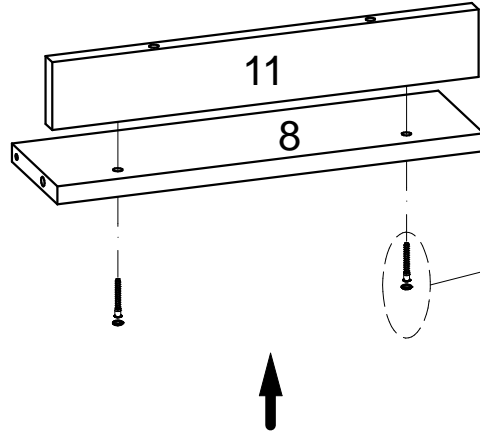

6

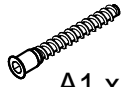

A1 x 3



A2 x 3



A3 x 1

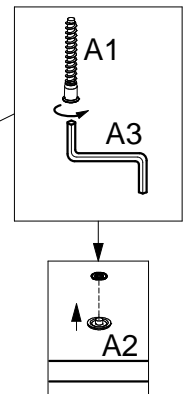
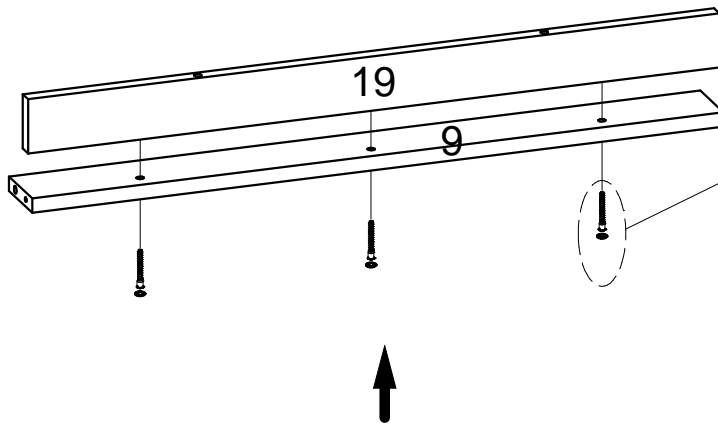

7

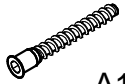

A1 x 9



A2 x 9



A3 x 1

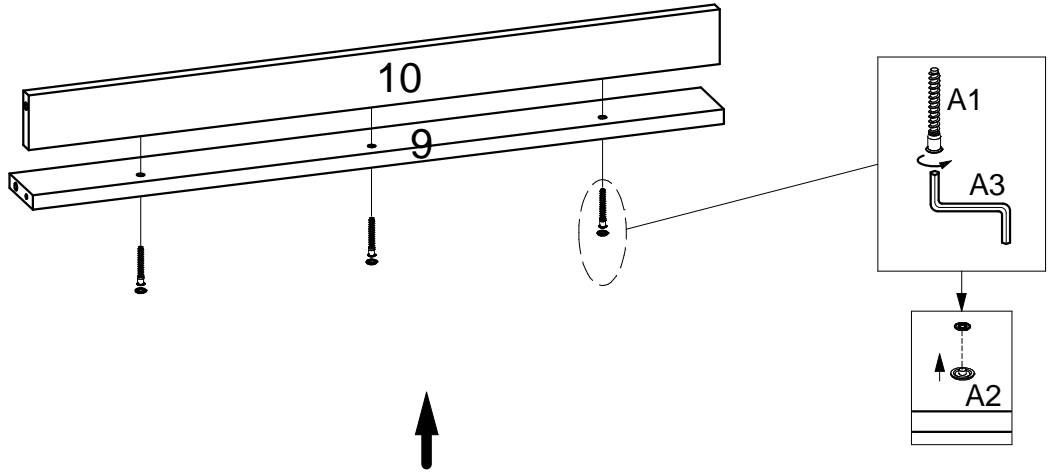

x 3

8



A1 x 10



A2 x 10



A3 x 1

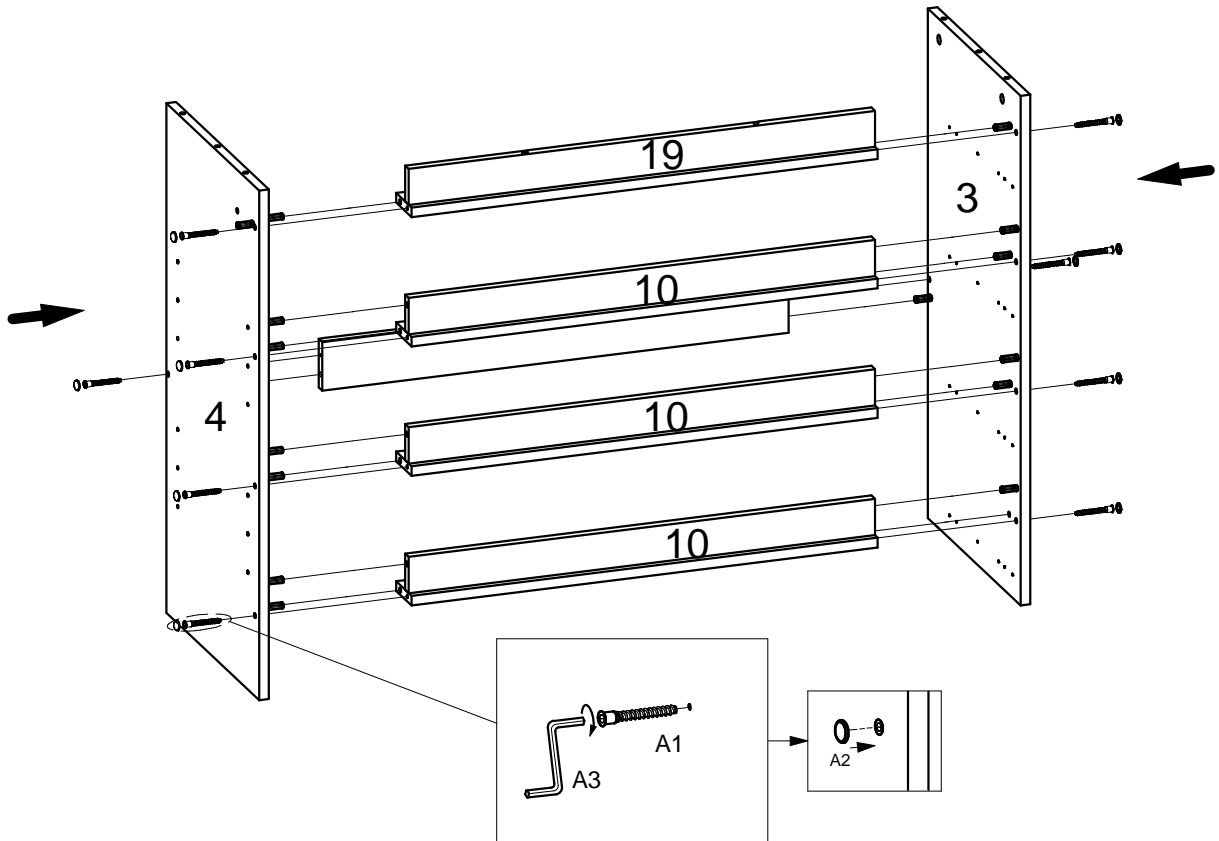
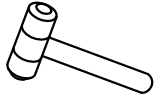

9

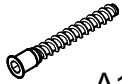

A1 x 2



A2 x 2



A3 x 1

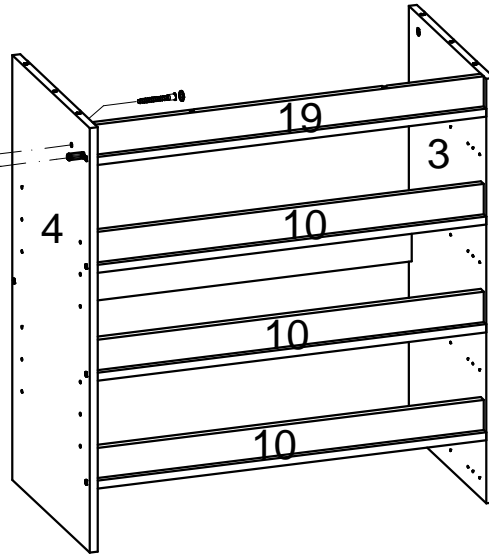
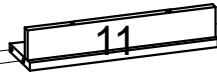
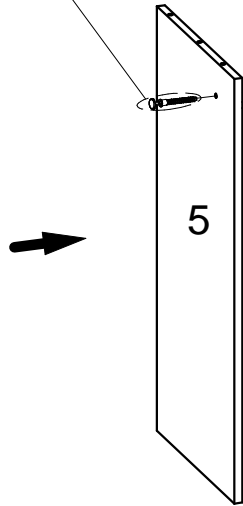
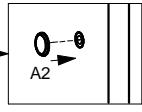
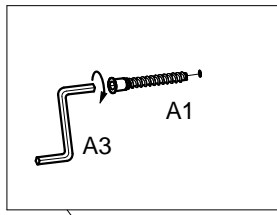
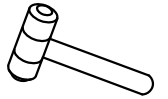

10

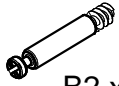

B2 x 6



G x 7

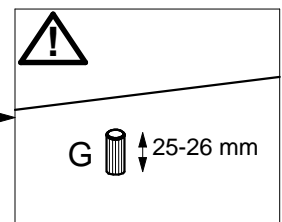
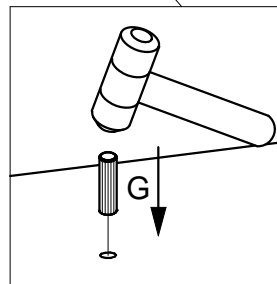
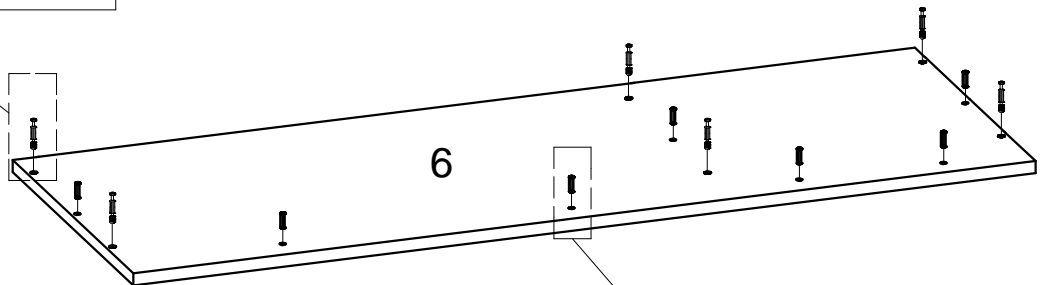
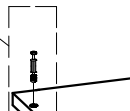
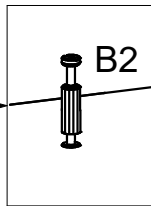
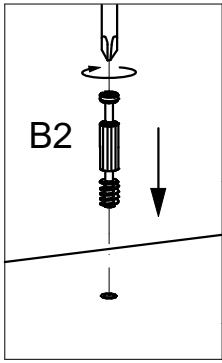
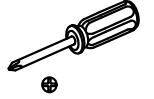
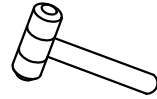

11

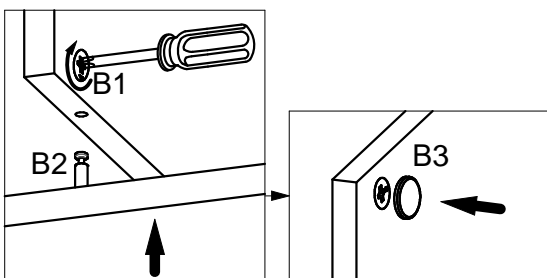
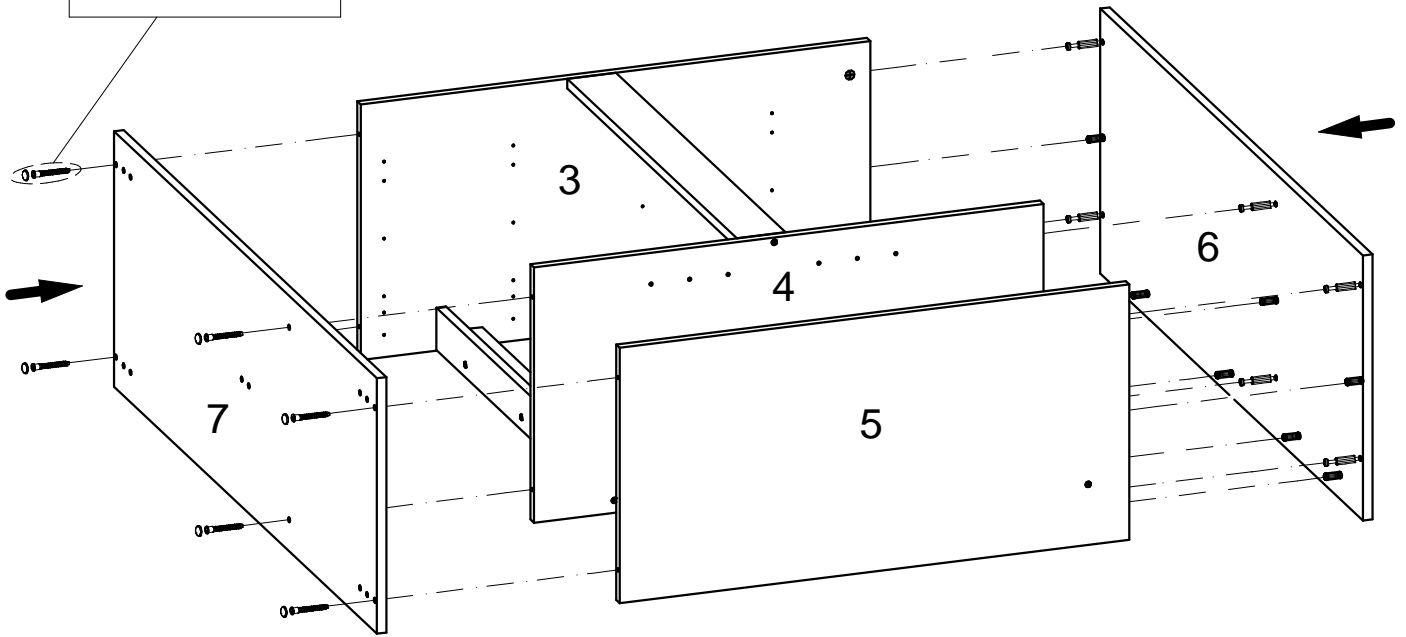
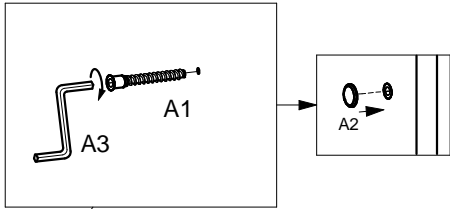
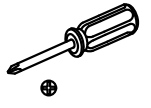
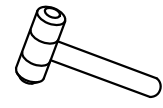
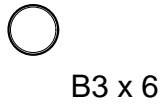
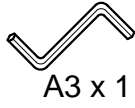
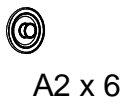
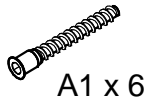

12

- C x 4
- D3 x 4
- D2 x 7
- F x 46
- N x 5
- Z x 7
- O1 x 1
- O2 x 1

⚠ XX=YY≅90°

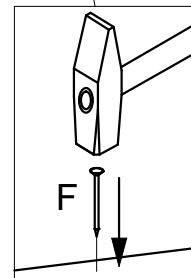
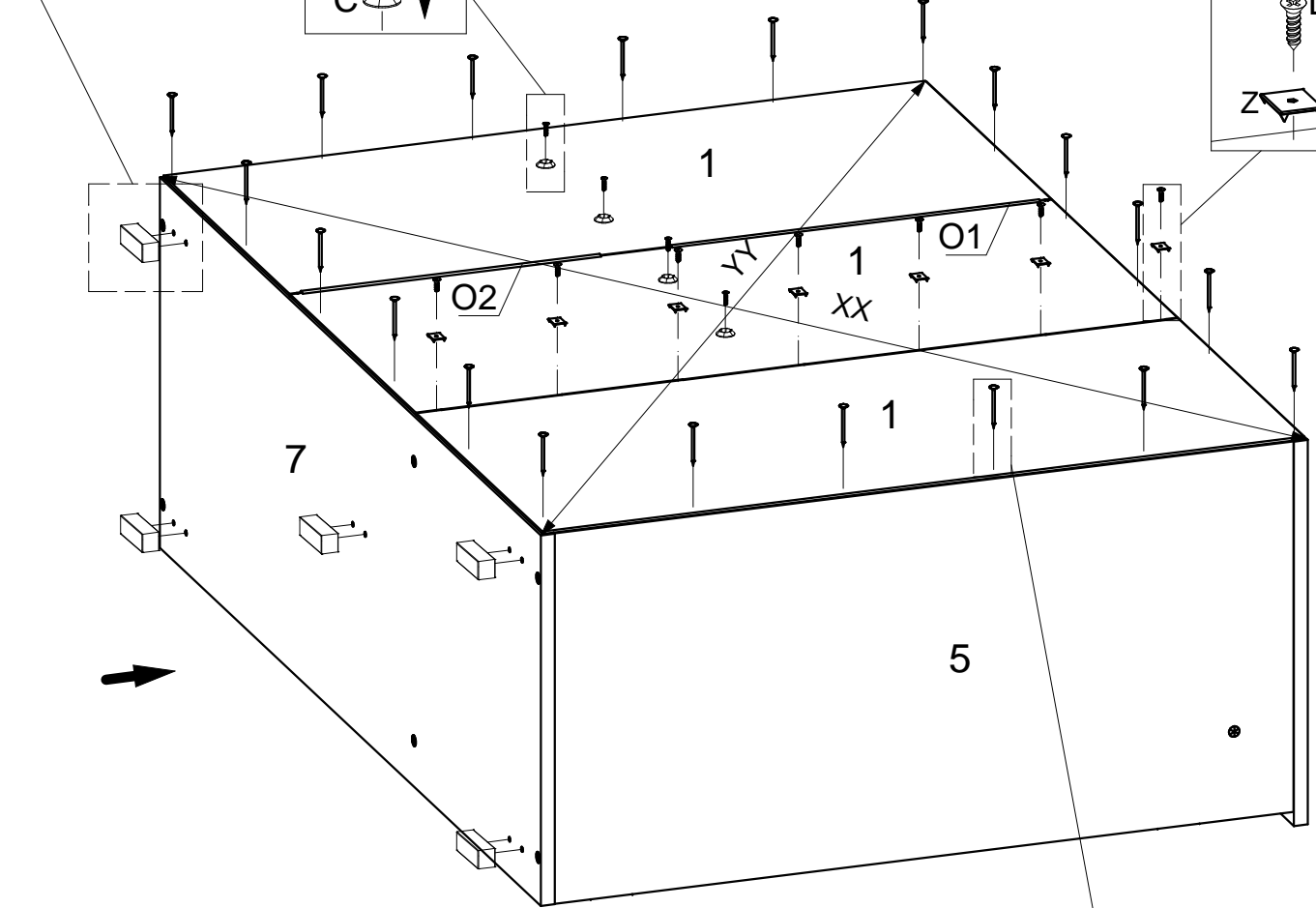
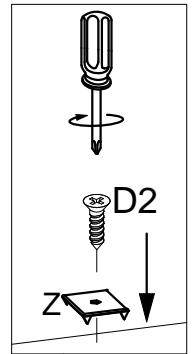
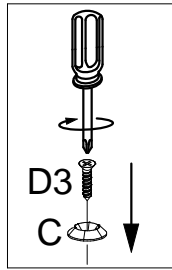
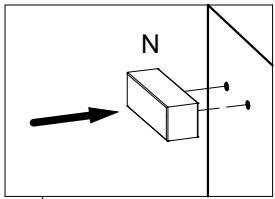
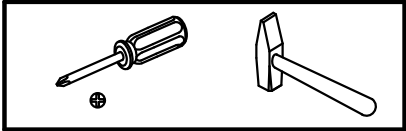

13



D1 x 24

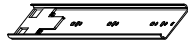

K.1 x 4



K.2 x 4

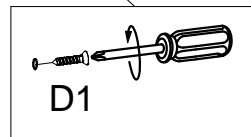
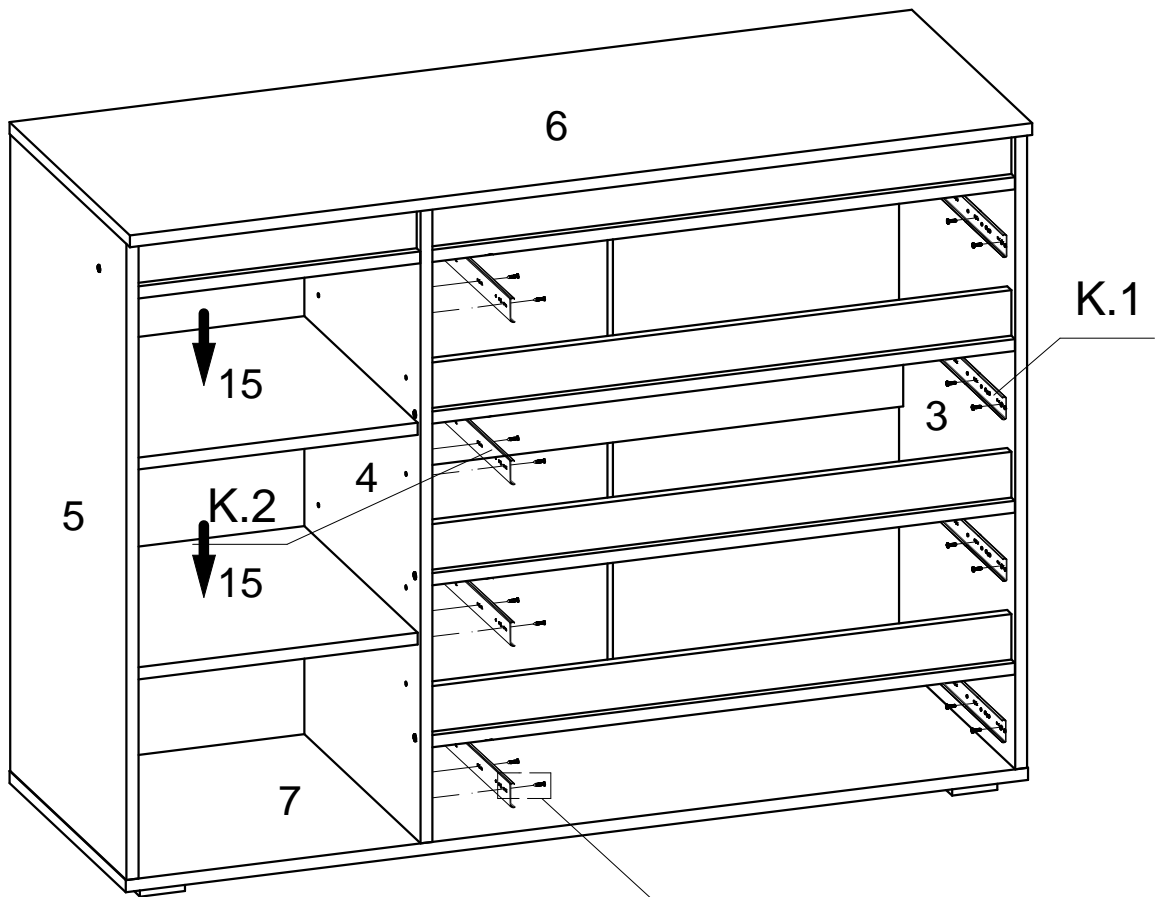
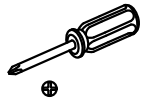

D1

14

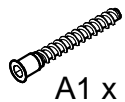

A1 x 16



A2 x 16



A3 x 1



B1 x 8

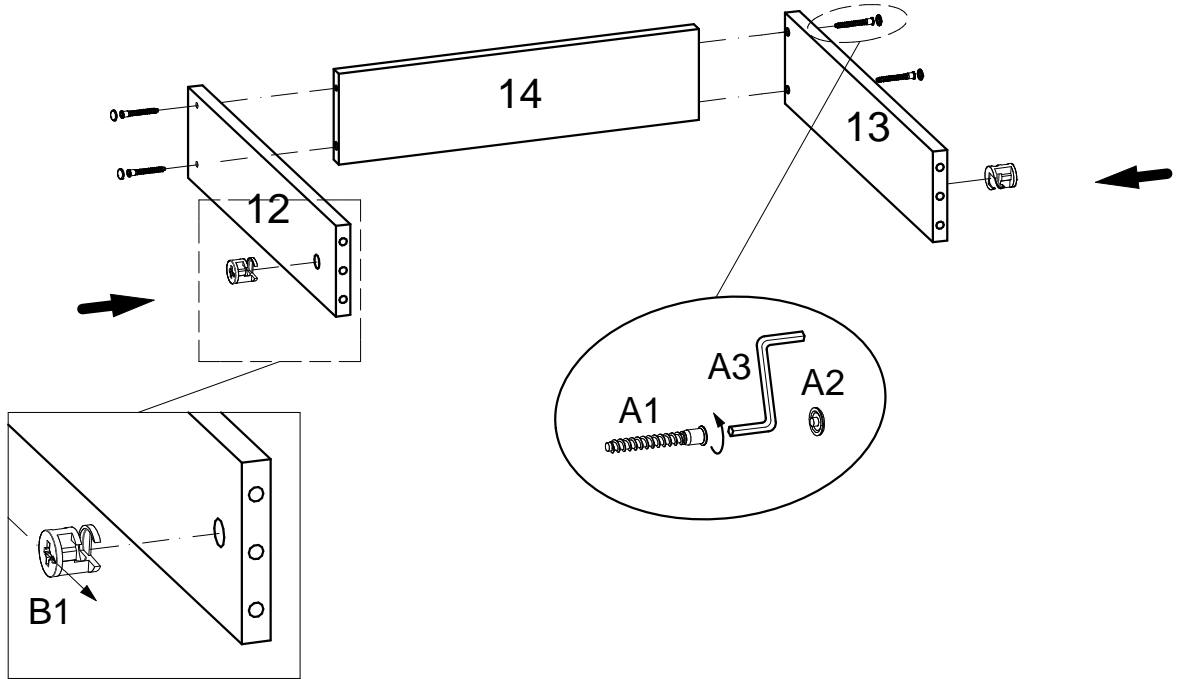

x 4

15

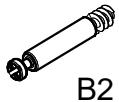

B2 x 8



B3 x 8



G x 16

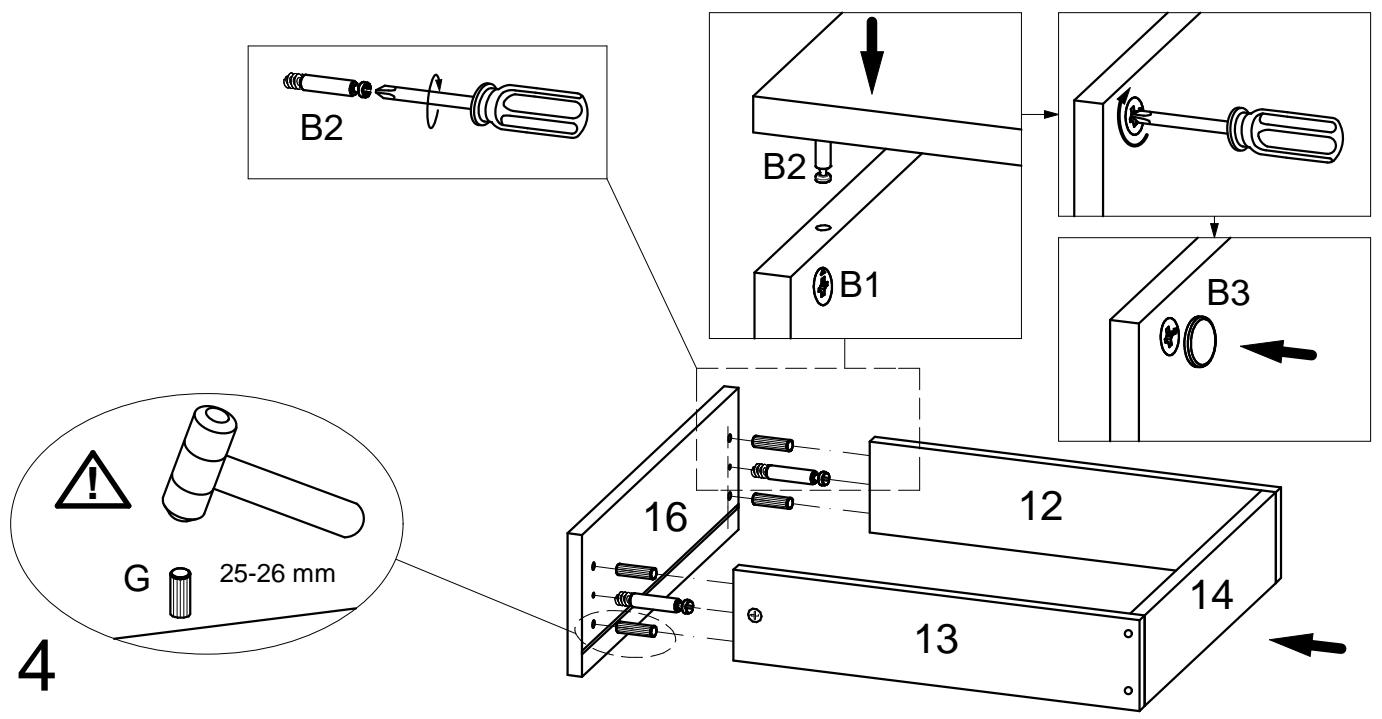
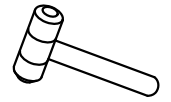
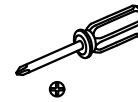

x 4

16

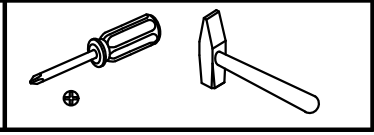
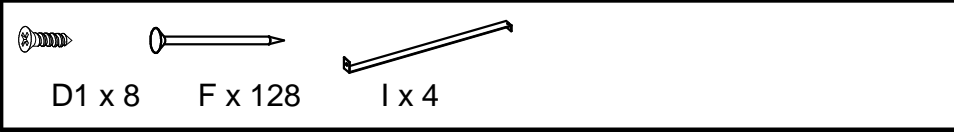

⚠ XX=YY≅90°

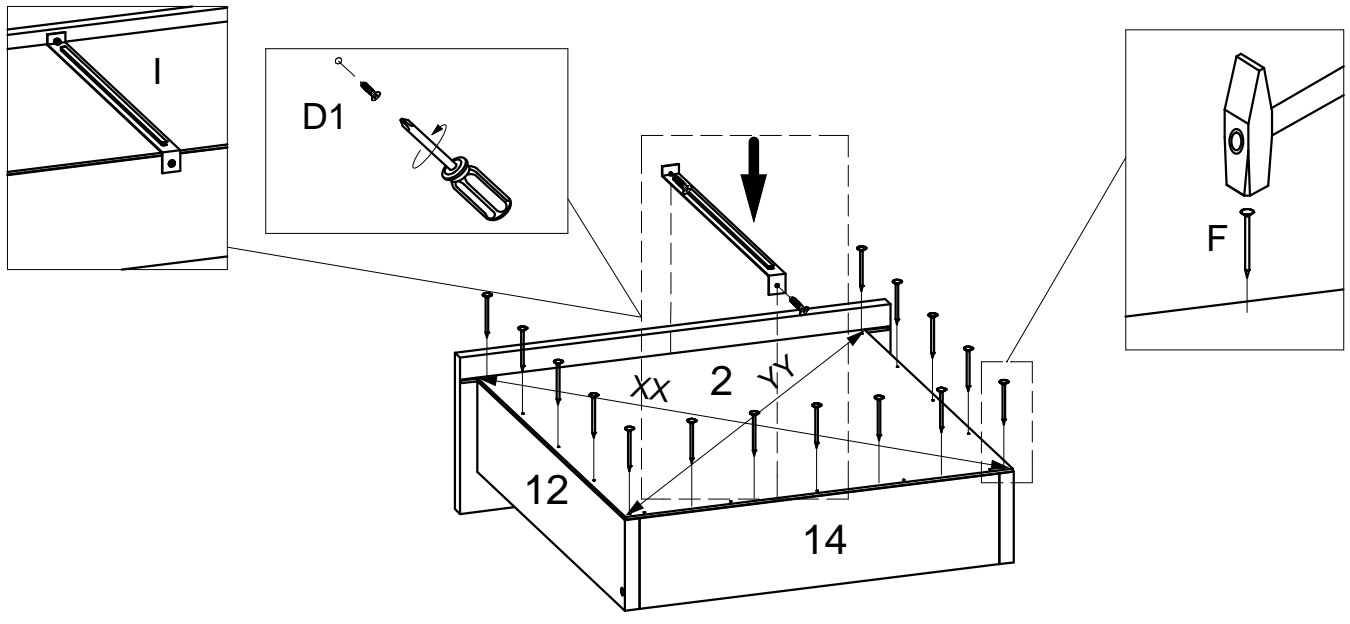

x 4

17

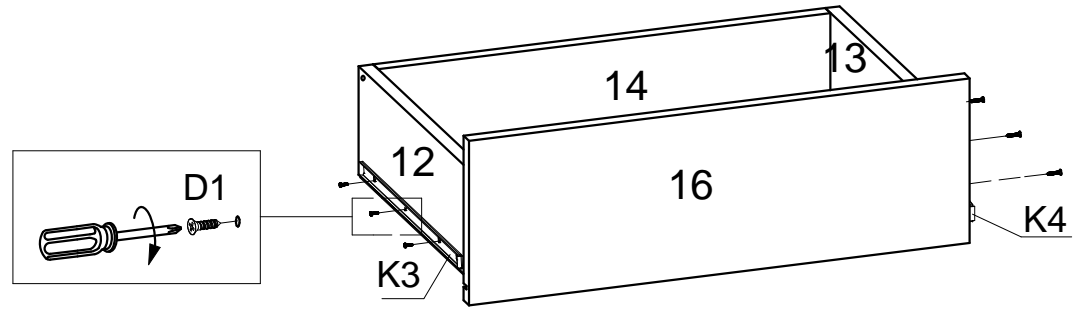
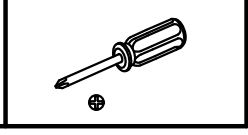
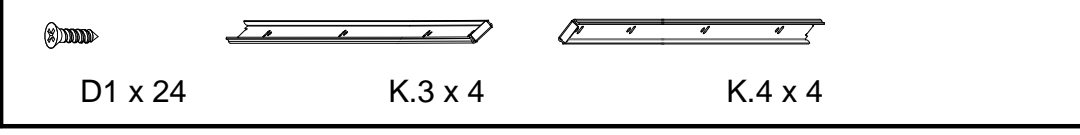

x 4

18



D1 x 4

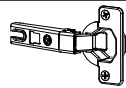

M.2 x 2

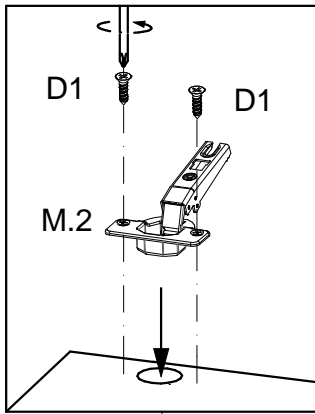
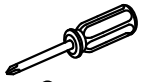

D1
M.2

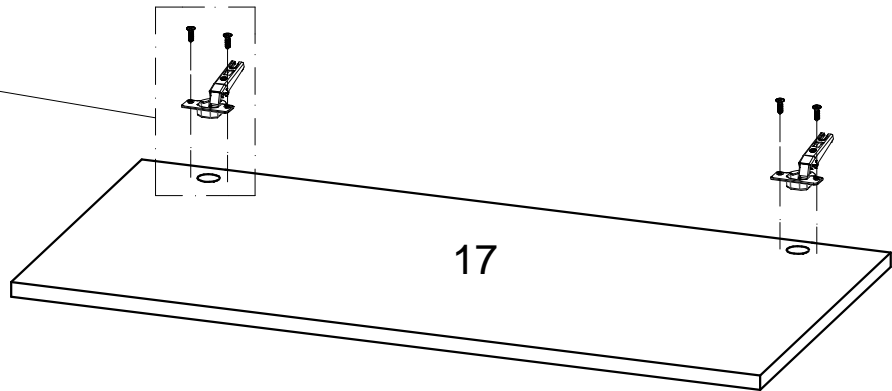

17

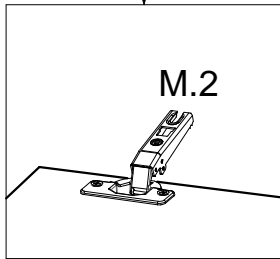

M.2

19

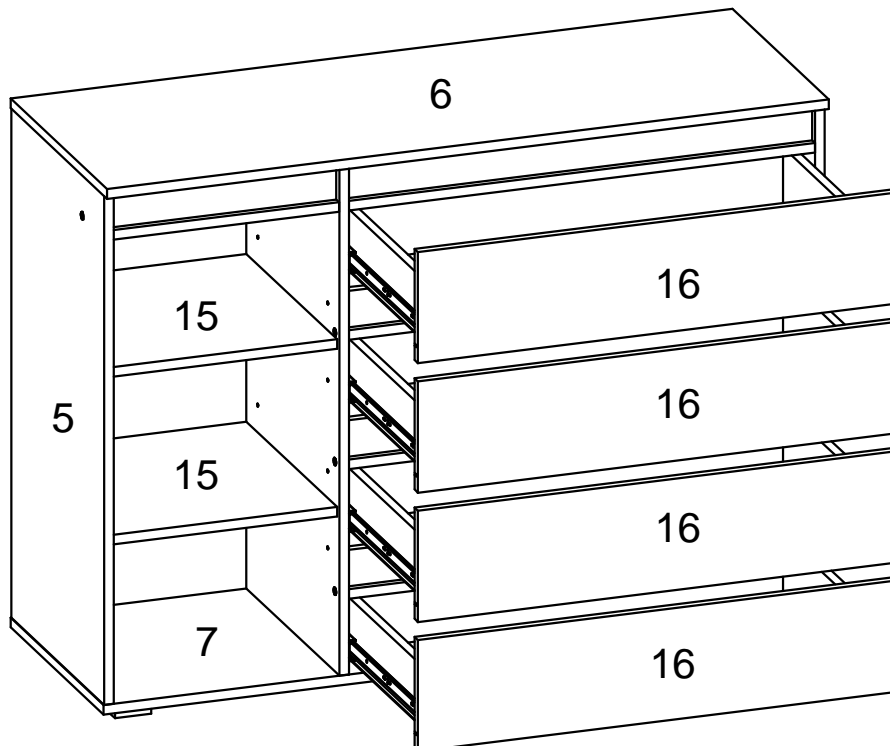

20

