

SIMA SKRINA

Art.-Nr.

233559
233560

600
1850
352
mm

1/5
Z0



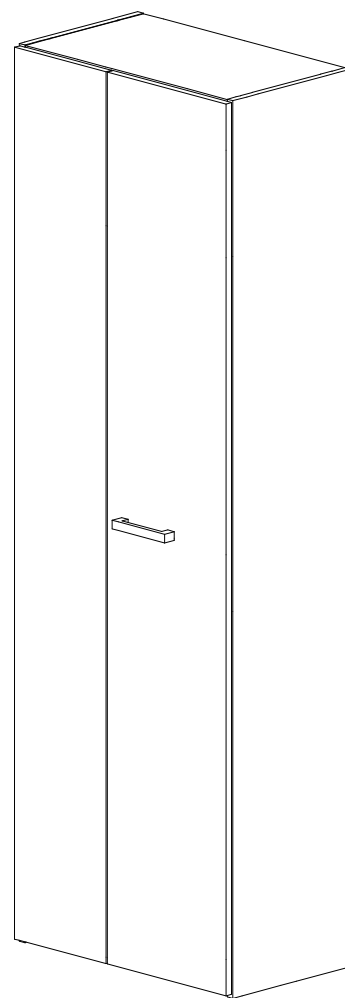
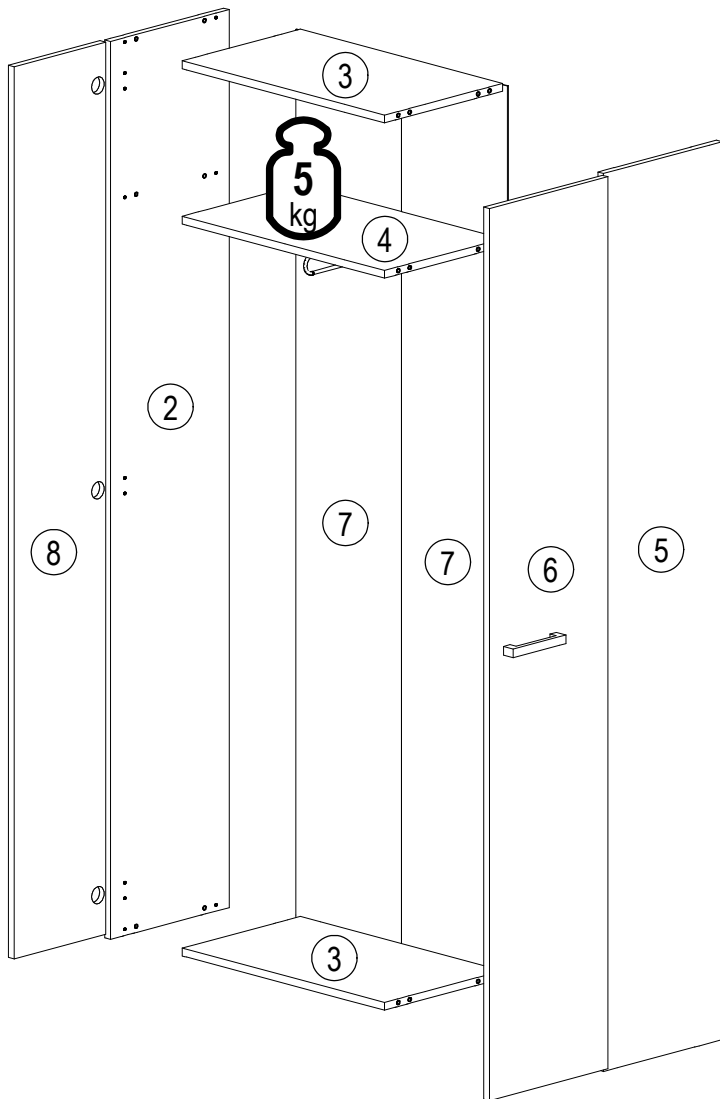

ID	ID			
15471	②	1850*333*16	1x	1/1
15472	③	568*332*16	2x	1/1
15473	④	568*332*16	1x	1/1
15474	⑤	1850*333*16	1x	1/1
15477	⑥	1838*333*16	1x	1/1
15475	⑦	1838*297*2,5	2x	1/1
15476	⑧	1838*257*16	1x	1/1

60 min		3m	
≤ 0,5 kg	PZ 2		
	600 mm		

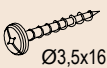
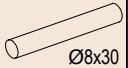

22244.01	Ø3,5x16	22213.00	Ø4x70	22243.00	Ø3,5x15	31103.00		27000.00	Ø8x30	30091.00		21102.00	Ø1,6x20	70013.01	Ø15x13	70021.01		36002.07	
A	6x	B	1x	C	12x	D	1x	E	12x	F	4x	G	50x	H	12x	J	12x	K	6x
L	8x	M	6x	N	1x	P	1x	Q	1x										

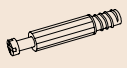
✓	✗	✓	✗	✓	✗	✓	✗	✗	✓
---	---	---	---	---	---	---	---	---	---

													
A	4x	E	12x	F	4x	H	12x	J	12x	M	6x	P	1x

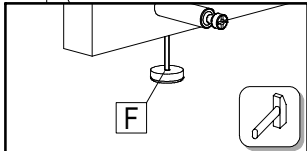
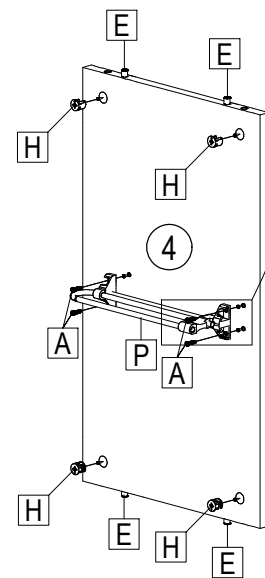
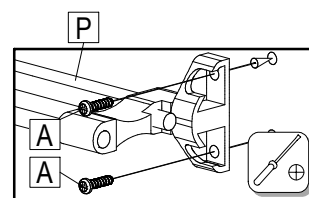
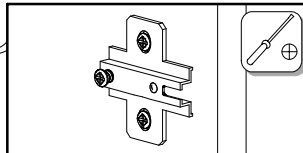
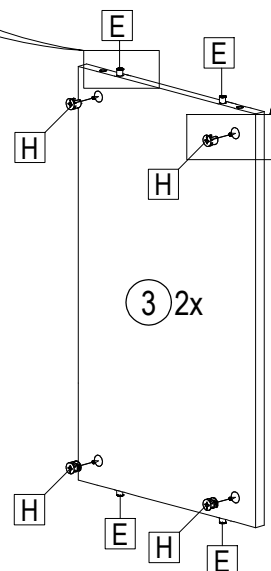
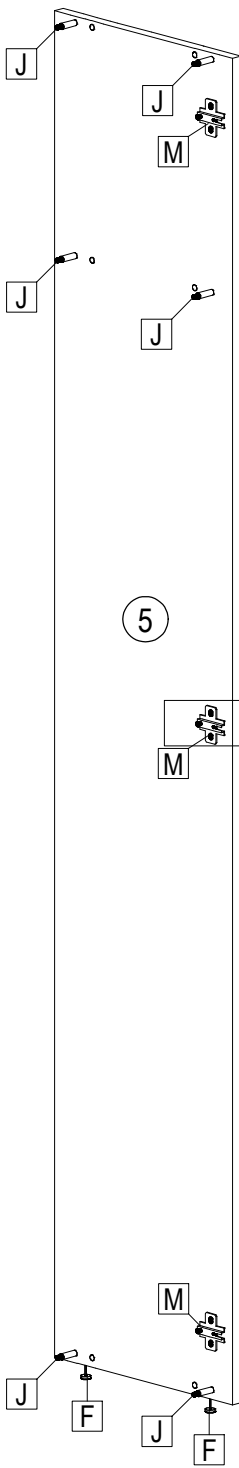
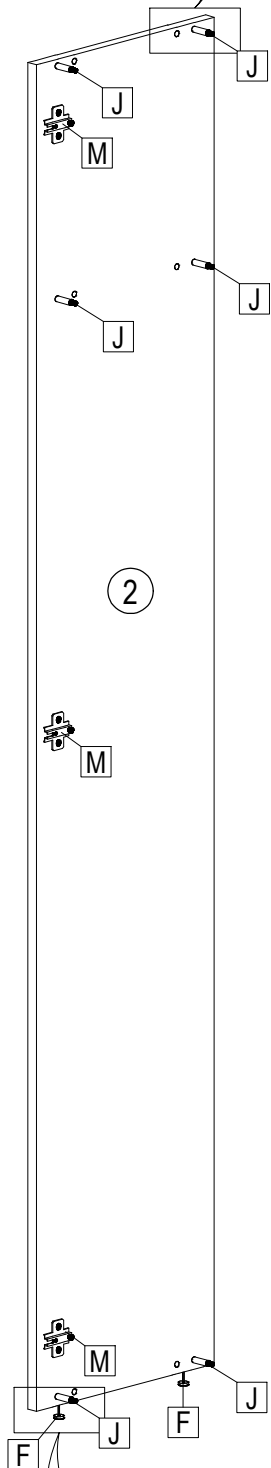
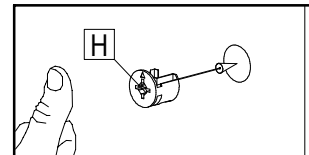
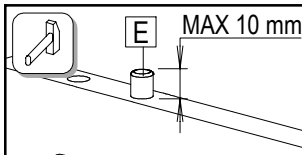
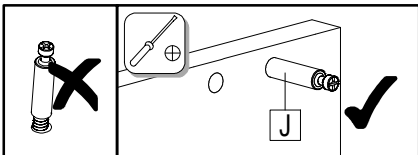

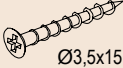
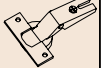
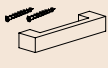

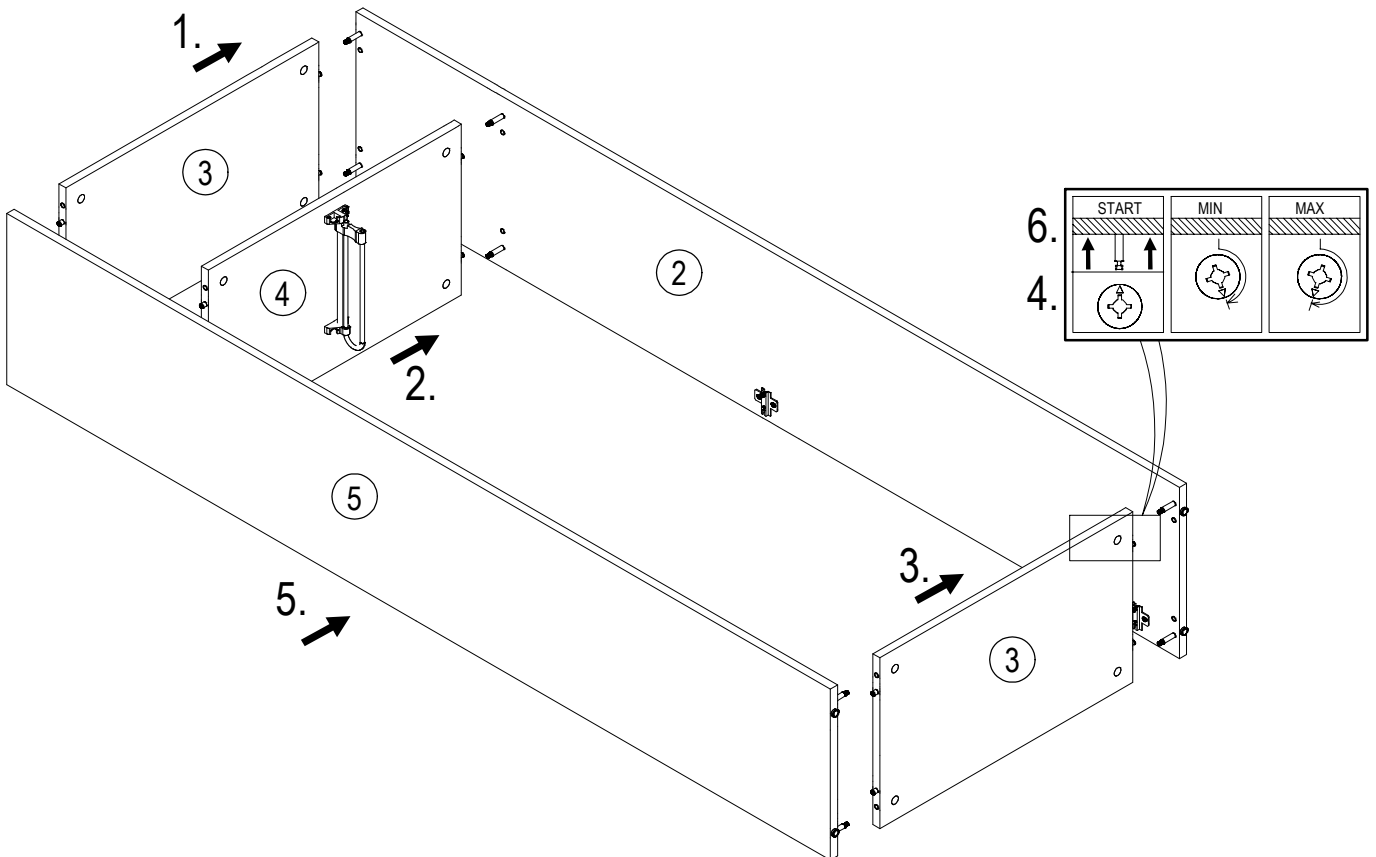
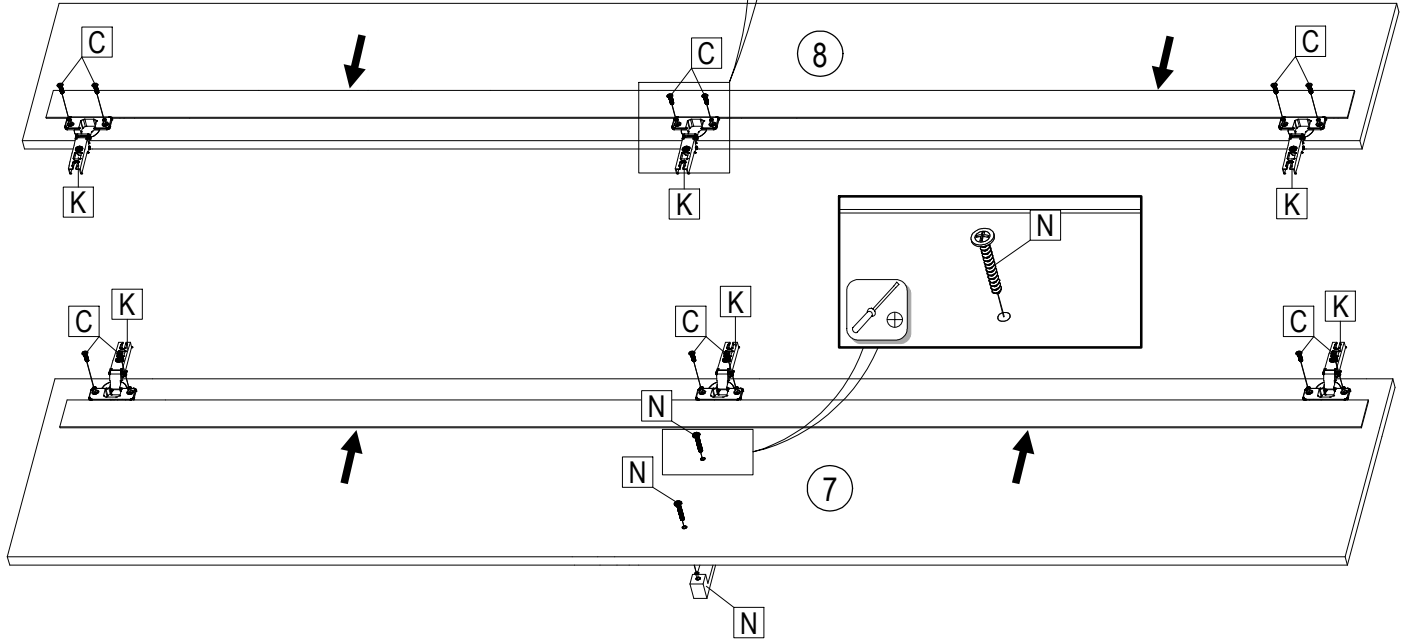
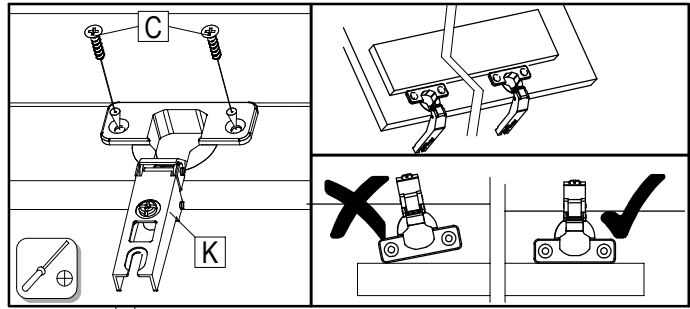
		
Ø3,5x15		
C 12x	K 6x	N 1x

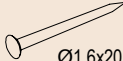

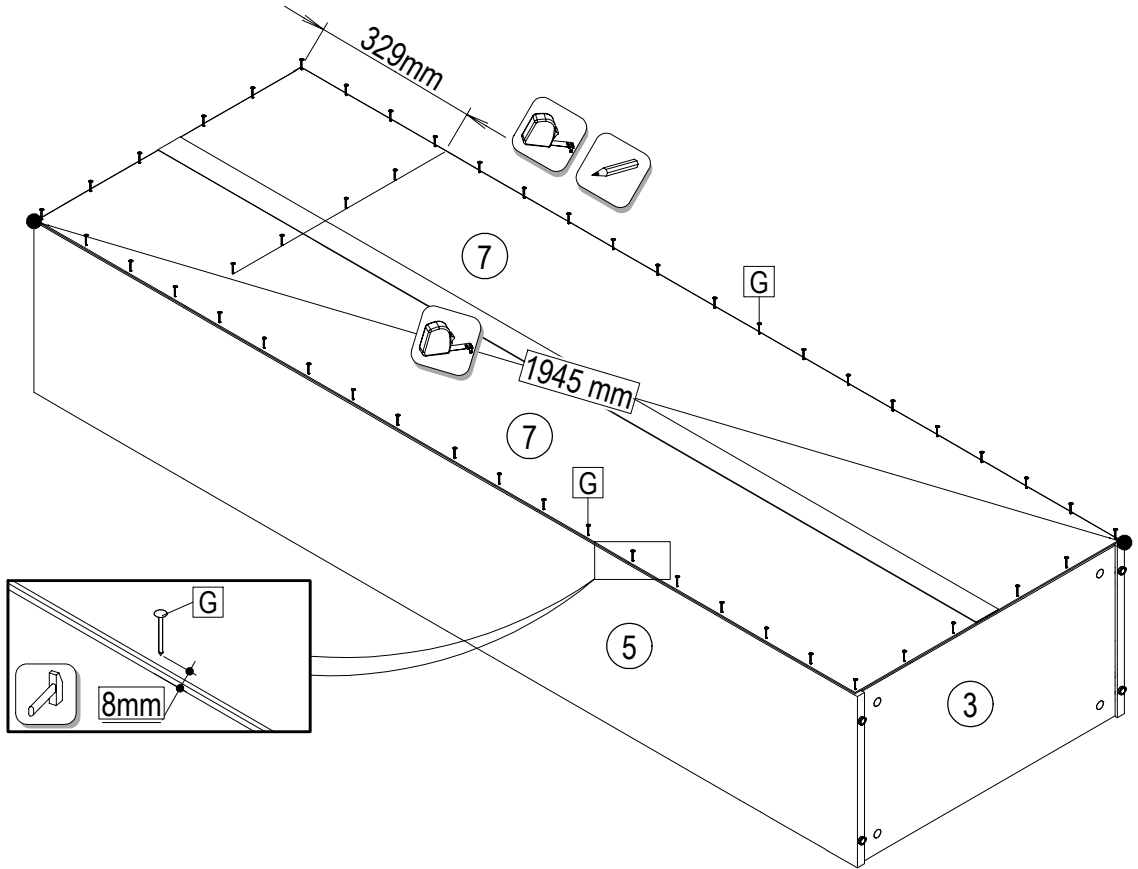
	Ø1,6x20
G	50x

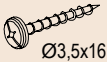
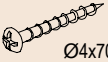

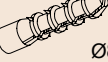
	Ø3,5x16		Ø4x70		1x		Ø8
A	2x	B	1x	D	1x	Q	1x

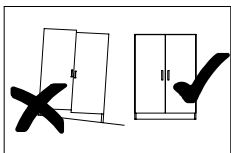
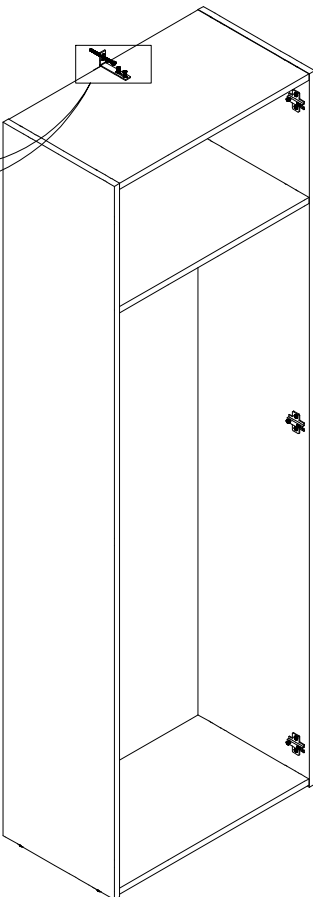
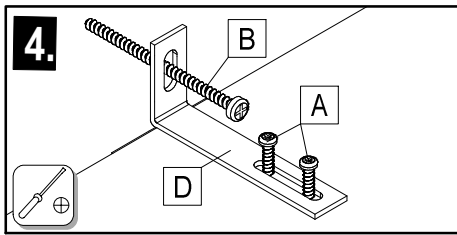
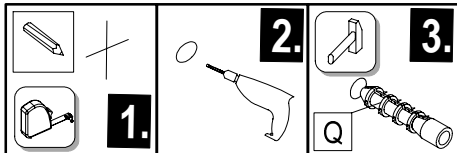

Prudență! Zidul trebuie examinat înainte de asamblare prizele de perete sunt adecvate numai pentru utilizarea în zidărie fermă, cum ar fi betonul, bloc sau cărămidă. Nu folosiți zidăria zidurilor de perete, cum ar fi cărămidă goală, blocul ușor, suprafețe cum ar fi gips-carton sau altă încadrare sisteme. Dacă este cazul, trebuie folosite anumite prize de perete! Acestea sunt disponibile la un magazin specializat (magazin de hardware). În caz de nerespectare, producătorul / vânzătorul cu amănuntul sau importatorul nu își asumă răspunderea.

Upozornenie! Pevnost' steny sa musí pred montážou bezpodmienečne skontrolovať. Univerzálne hmoždenky, ktoré sú obsiahnuté v balení, používajte jedine pre pevné murivo ako je betón/tehla. Hmoždenky sa nesmú používať v prípade ľahkého staveného muriva, dutina tehla, u sádrokartónových dosiek alebo iných konštrukcií rámu. U týchto murív je nutné použiť špeciálne hmoždenky! Tieto je možné dostať v špeciálnych predajniach so stavebným materiálom (stavebniny). Pri nedodržaní pokynov nepreberajú výrobcovia/predajci a dodávateľia zodpovednosť za vzniknuté škody.

Achtung! Die Wandbeschaffenheit ist vor der Montage unbedingt zu prüfen. Die beigelegten Universaldübel sind ausschließlich nur zur Verwendung für festes Mauerwerk wie Beton/Ziegel. Die Mauerdübel dürfen nicht bei Mauerwerk wie Hohlraumziegel, Leichtbausteinen, Gipskartonplatte oder anderer Rahmenbauweise verwendet werden. Bei diesen Mauerwerken sind gegebenenfalls Spezialdübel zu verwenden! Diese sind in einem Fachgeschäft (Baumarkt) erhältlich. Bei Nichteinhaltung wird seitens Produzenten/Händler und Importeur keine Haftung übernommen.

Vigyázat! Szerelés előtt a falfelületet feltétlenül vizsgálja meg. A mellékelt univerzális tiplik kizárólag stabil falazathoz használható mint például beton/égla. A fali tiplik nem használható könnyű építőkövek hez, üreg téglá, gipszkarton lapokhoz vagy más favázás építményekhez. Ezekhez a falfelületekhez csak speciális tiplik használhatóak, melyek szaküzletekben (barkácsruházakban) beszerezhetőek. Fentiek figyelmen kívül hagyása esetén a gyártó/kereskedő vagy forgalmazó nem vállal felelősséget.

Upozornění! Před montáží je nutné zkontrolovat stav stěny. Přiložené univerzální hmoždinky jsou určeny pouze k použití pro pevné zdivo jako beton/cihly. Hmoždinky do zdi se nesmí používat u dutinová cihla, zdiva jako pórovitý stavební kámen, sádrokartónová deska nebo jiný měkký materiál. U těchto zdív jsou nutné použít speciální hmoždinky! Jsou k dostání v speciálních prodejnách se stavebním materiálem. Při nedodržení těchto pokynů výrobce/prodejce a dovozce neručí za způsobené škody.

Pažnja! Prije montaže obavezno provjerite svojstvo zida. Priložene univerzalne tiplje namijenjene su isključivo za masivne zidove od betona/opeke. Tiplje za masivne zidove ne smiju se koristiti za zidove kao npr šupljina opeka laki sastavni elementi, gips-kartonske ploče ili drugi modularni načini gradnje. Za te zidove potrebne su eventualno specijalne tiplje! Iste su dostupne u specijaliziranim trgovinama građevinskim materijalom. U slučaju nepridržavanja prethodno navedenih napomena, proizvođač/trgovac i uvoznik ne preuzimaju odgovornost!

	
L	8x

