

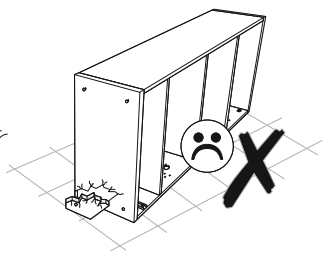

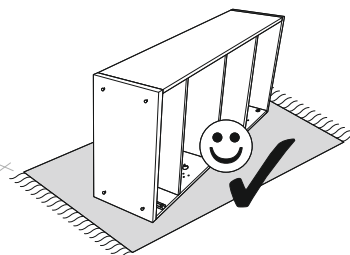

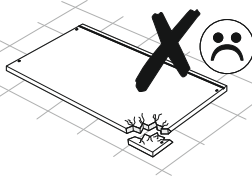

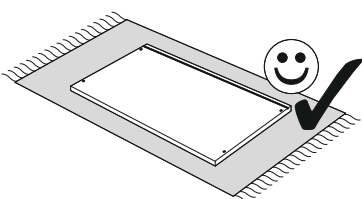

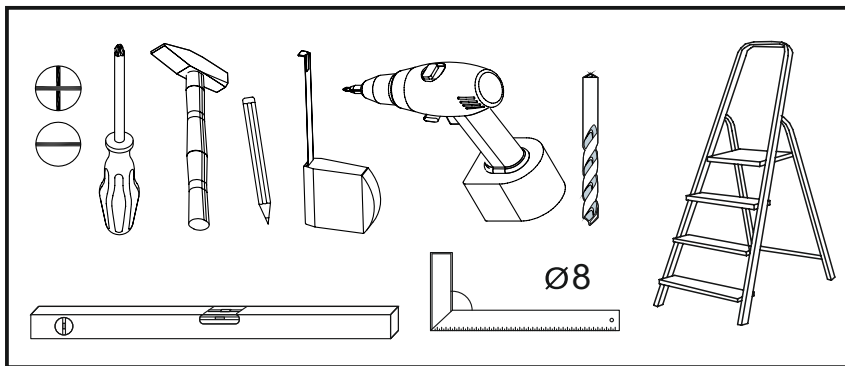
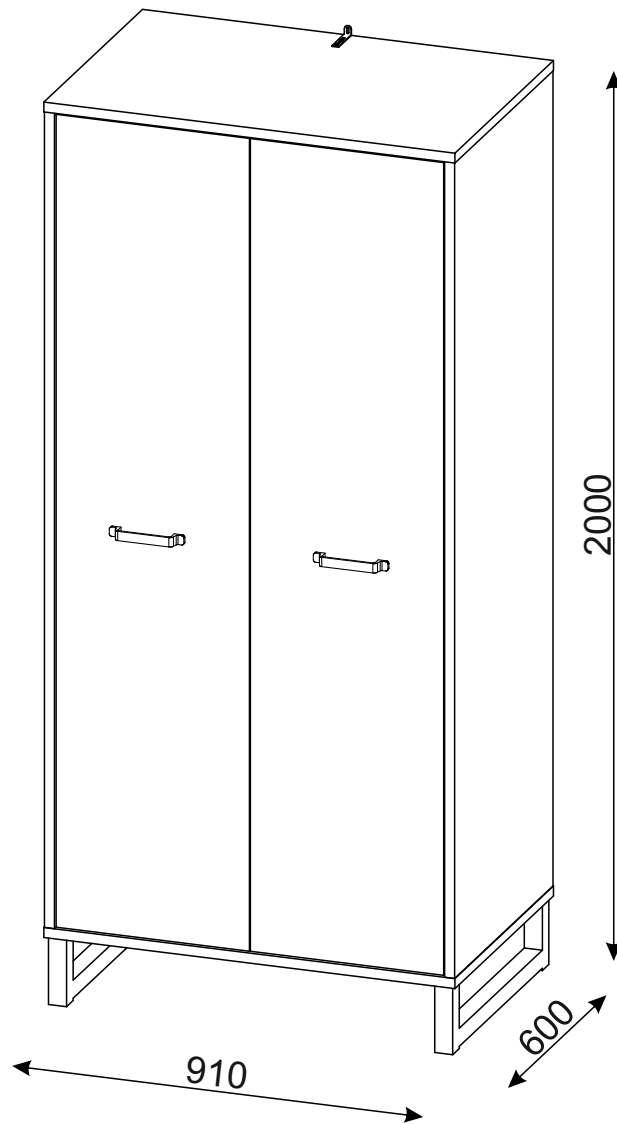
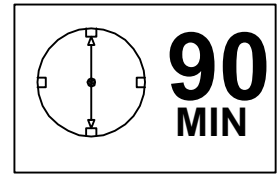
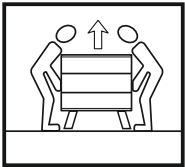
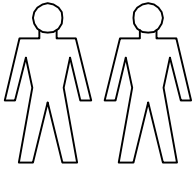









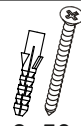

BARI Wardrobe 2D



BARI Wardrobe 2D

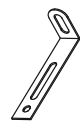
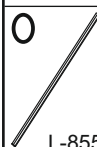
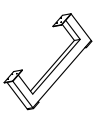





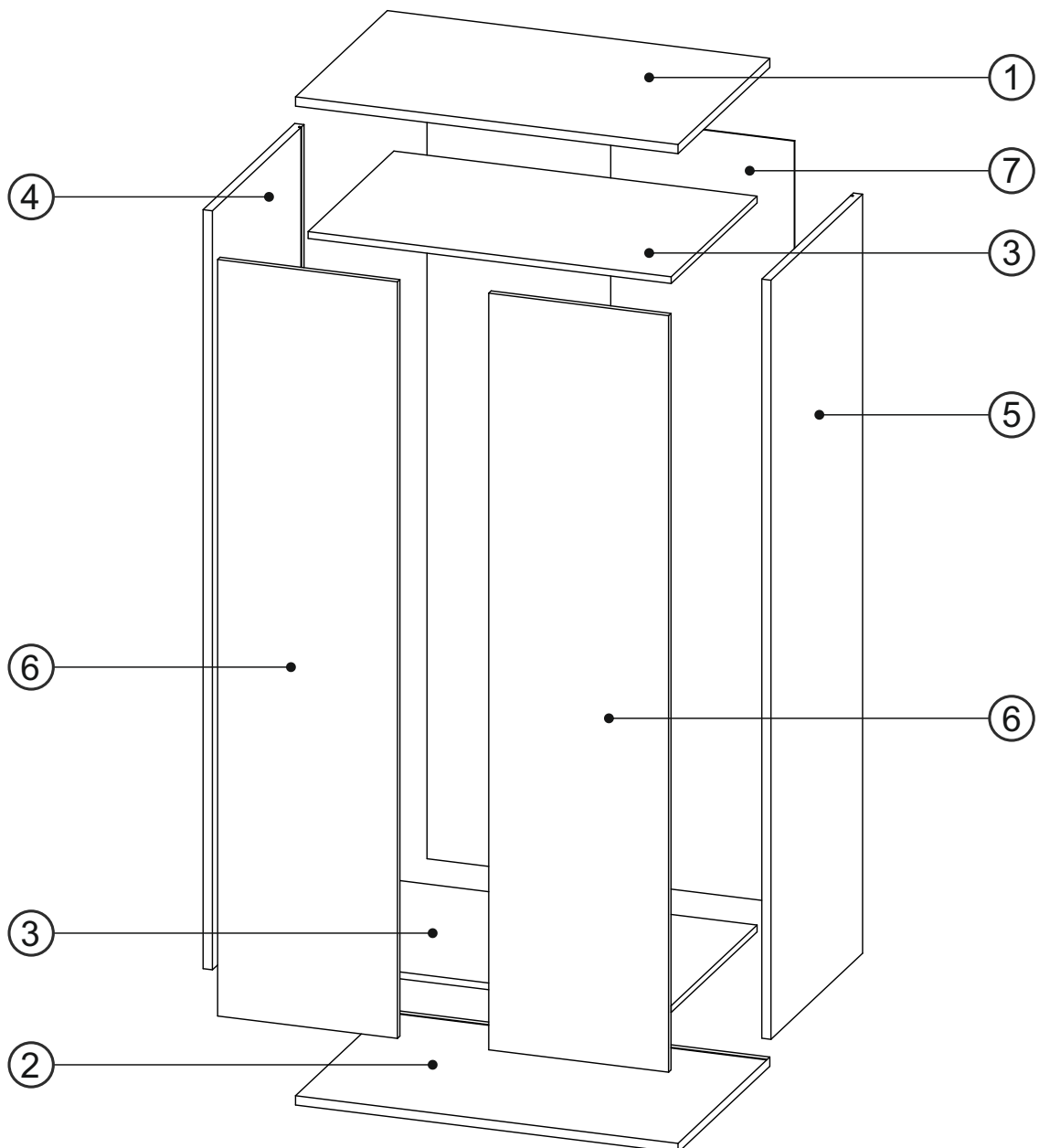

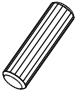

A0  ø8x30 x16	B2  ø7x70 x6	C0  ø16mm x18	C2  x18	C7  16mm x18	D0  3x15 x24	D3  3.5x10 x2	D5  3,5x16 x30	D8  3,5x13 x8	E0  8x50 x1	H2  4x22 x4
J4  x8	J6  x8	K  4mm x1	L42  x2	M1  x24	O0  x2	P0  x1	S0  L-855 x1	T28  x2	U0  x4	

BARI Tall cabinet 3D

①	910	600	22	x1	1/4
②	910	600	22	x1	1/4
③	864	561	16	x2	1/4
④	1806	599	22	x1	2/4
⑤	1806	599	22	x1	2/4
⑥	1800	428	16	x2	3/4
⑦	1816	874	3	x1	3/4
					4/4



1

A0  ø8x30 x8	C2  x12	C7  16mm x6	D3  3.5x10 x2	D5  3,5x16 x16	H2  4x22 x4	J4  x8	J6  x8	L42  x2	O0  x2
--	--	---	---	--	---	---	---	--	---

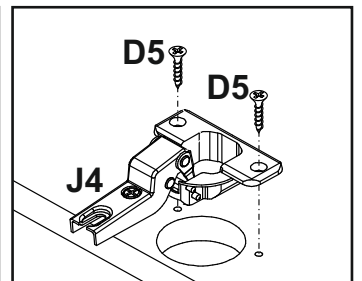
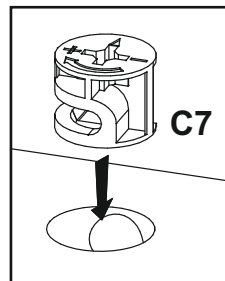
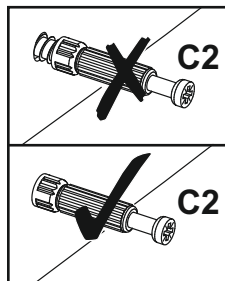
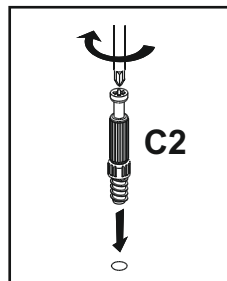
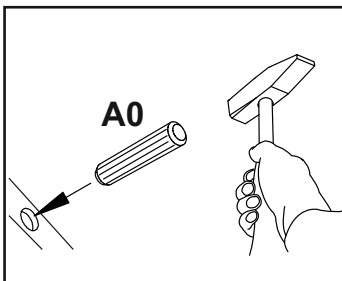
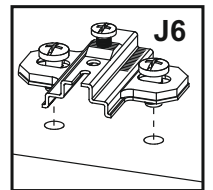
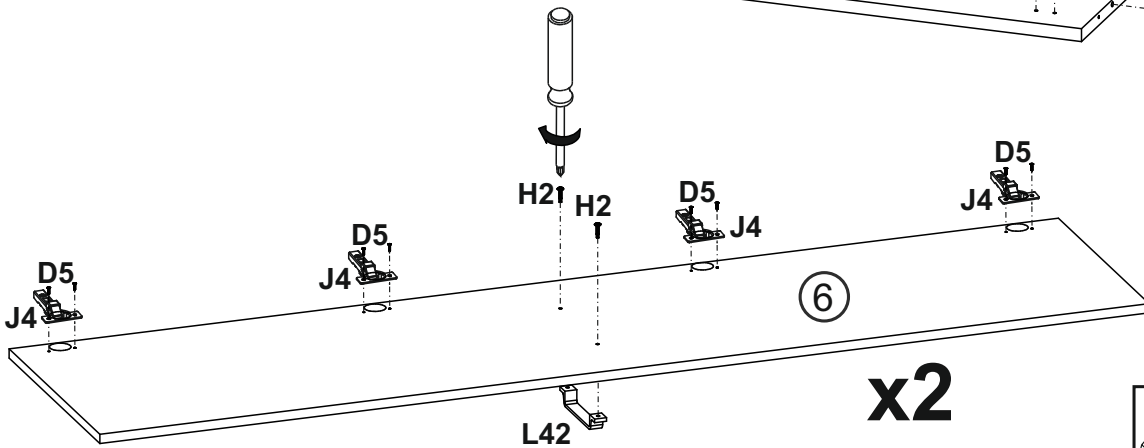
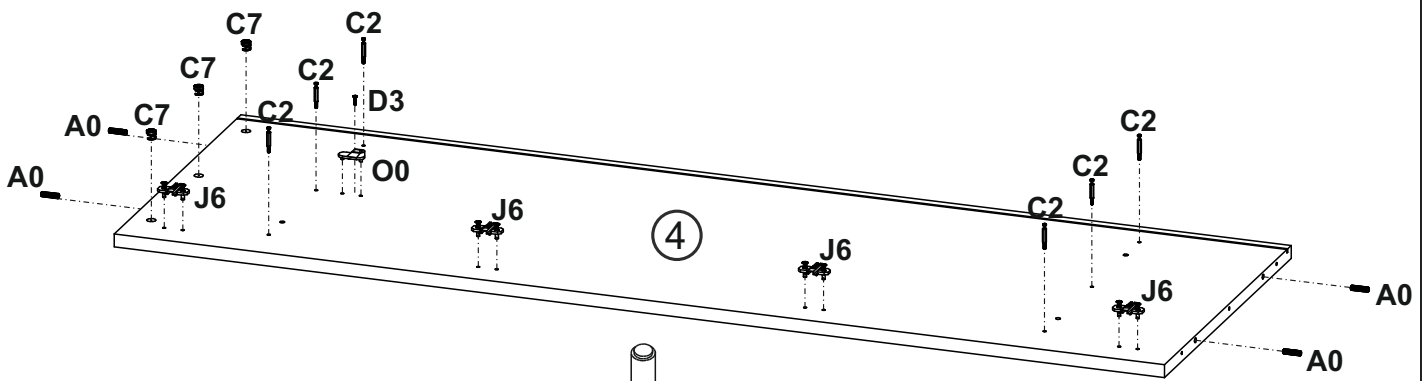
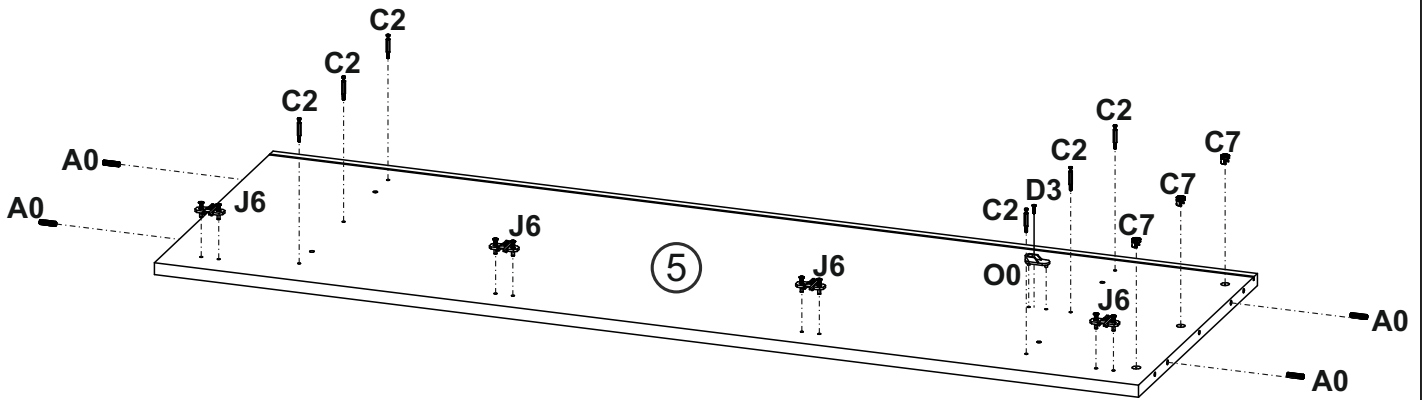



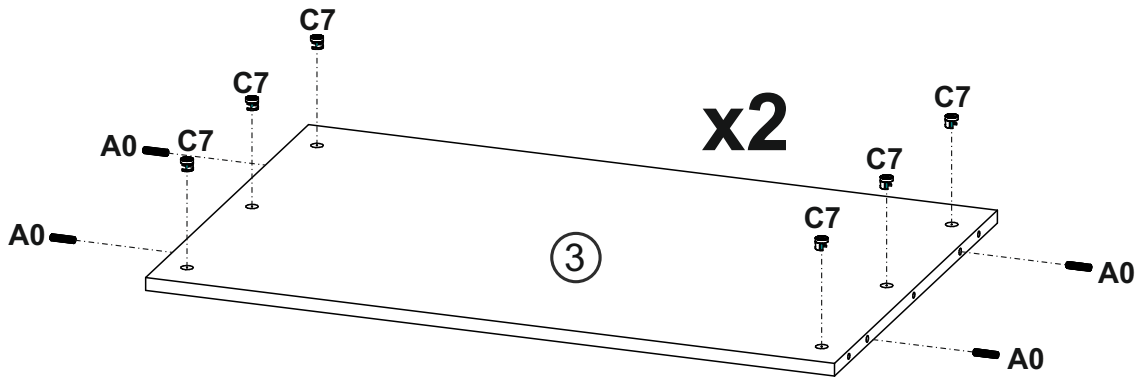
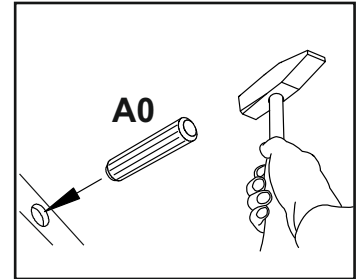
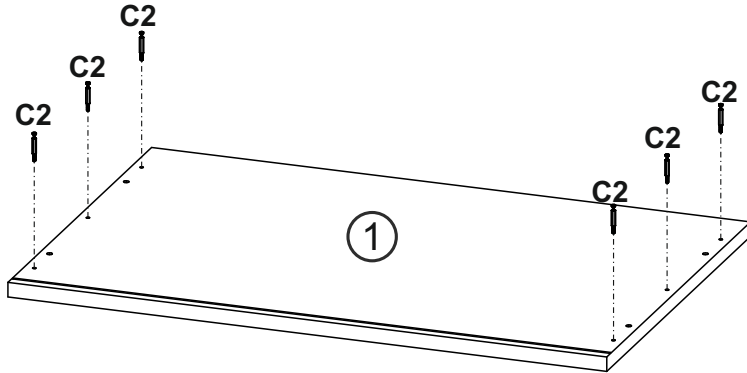
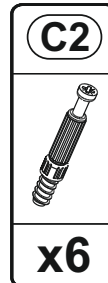
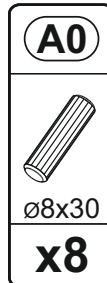
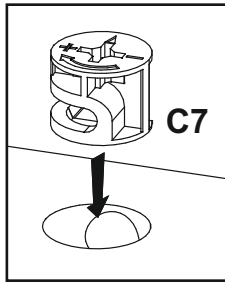
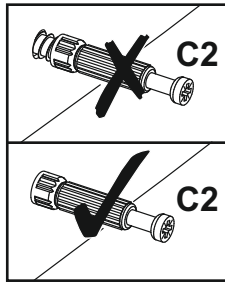
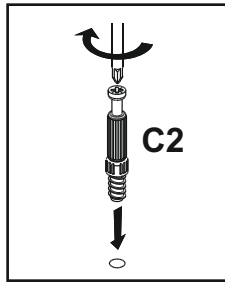

2

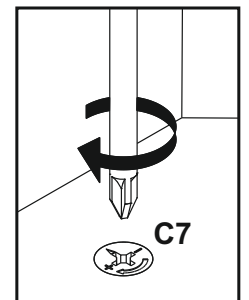
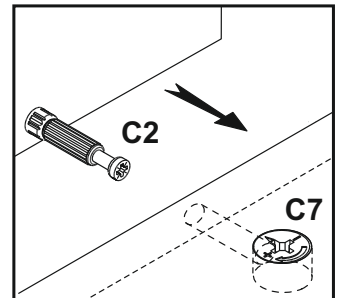
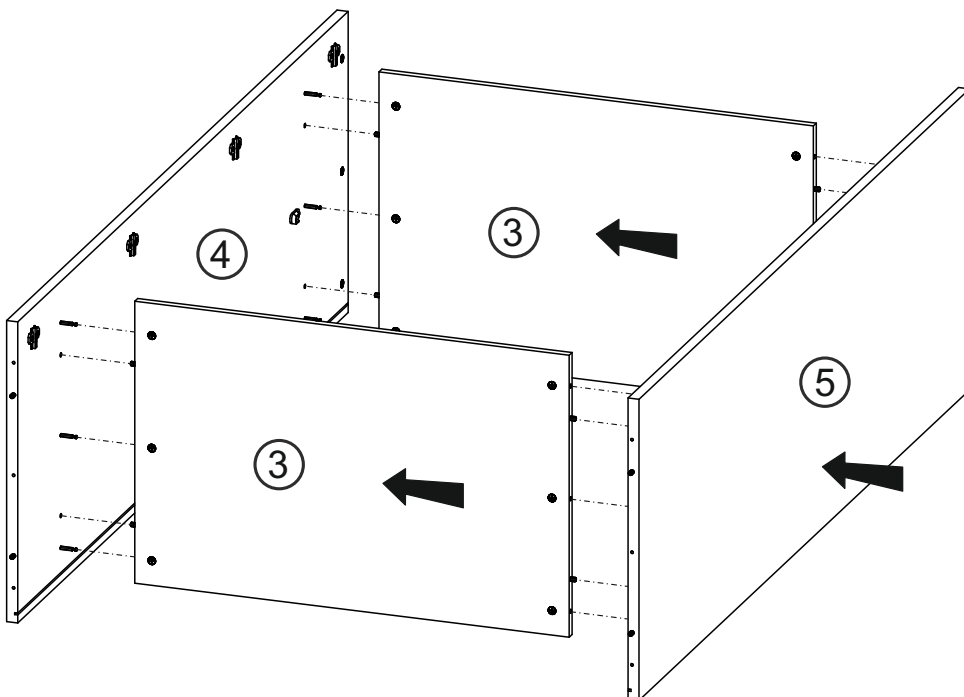

3

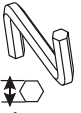

4

B2  ø7x70 x6	D5  3,5x16 x12	K  4mm x1	T28  x2
--	--	---	--

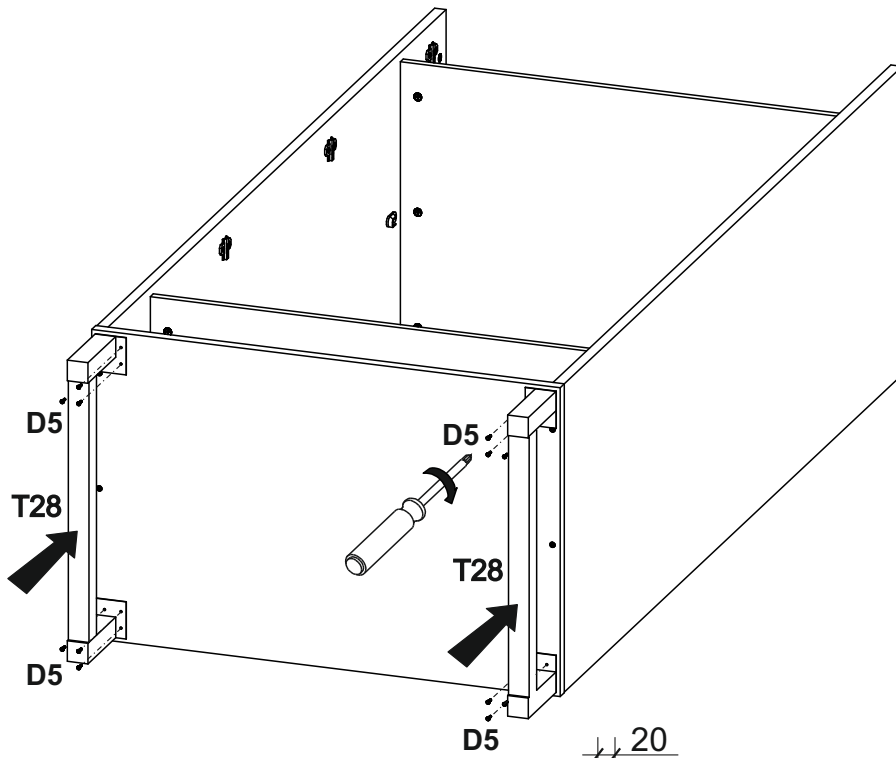
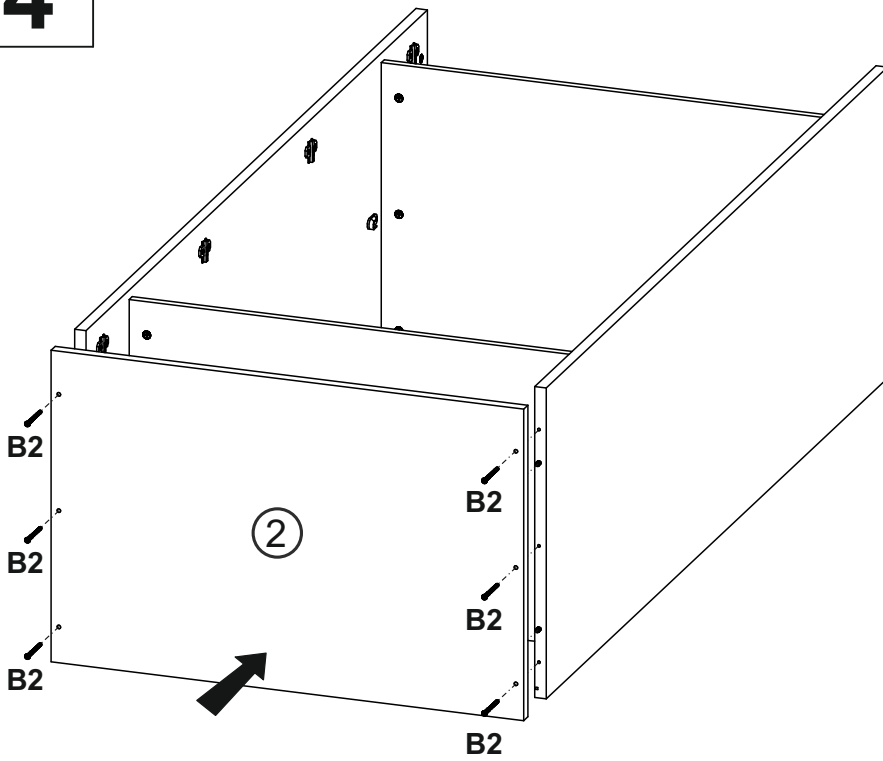
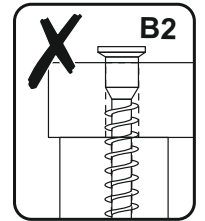
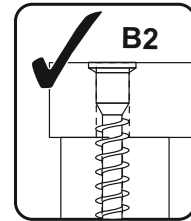
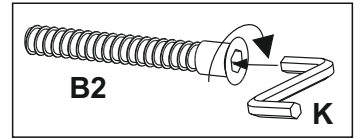

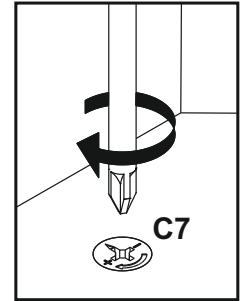
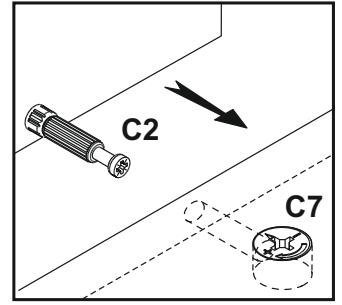
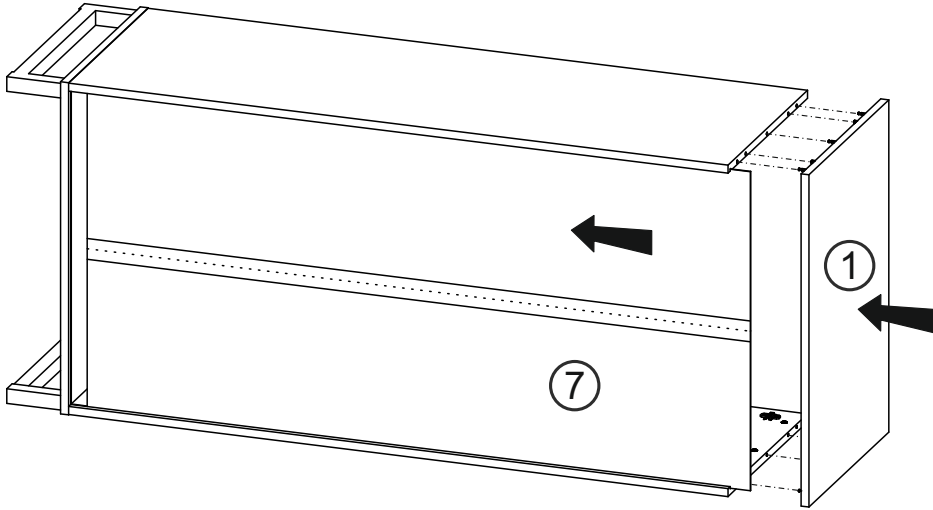

5



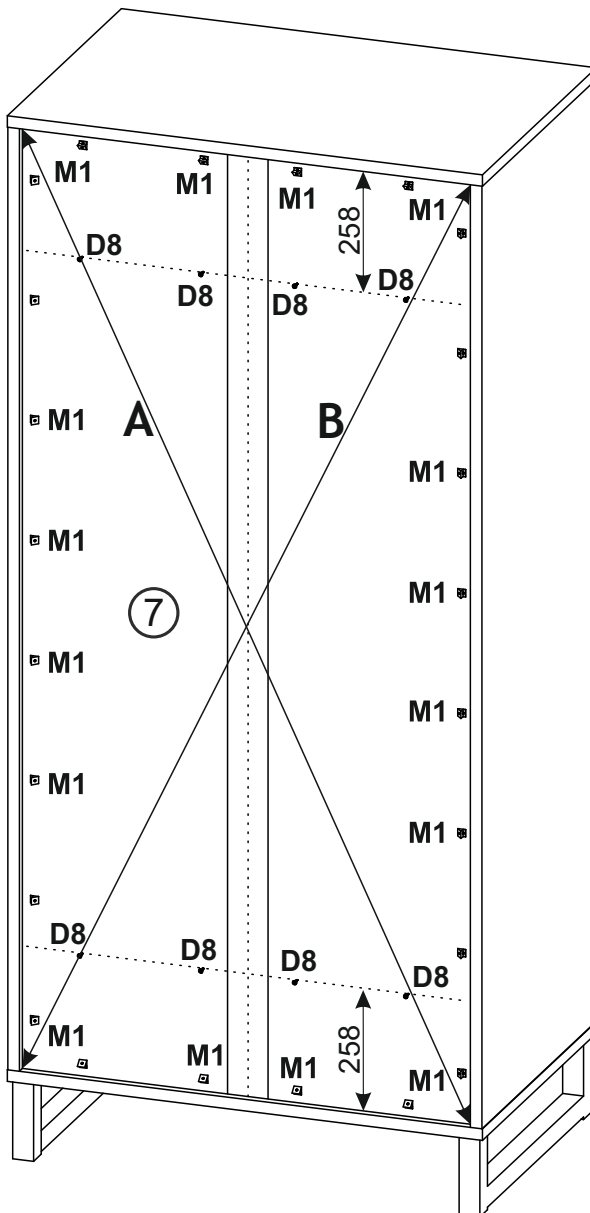

6

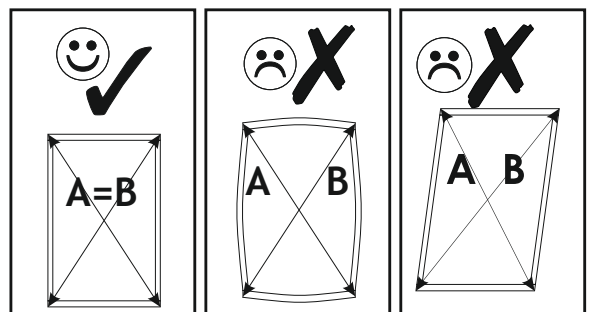
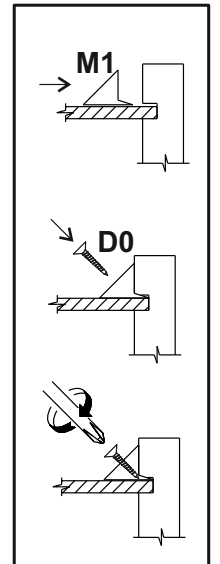

D0	D8	M1
		
3x15	3,5x13	
x24	x8	x24



7

C0	S0	U0
		
∅16mm	L-855	
x18	x1	x4

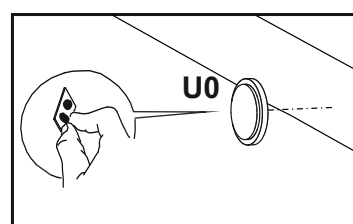
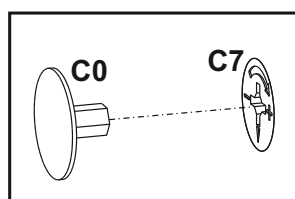
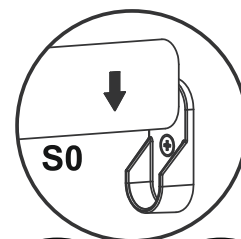
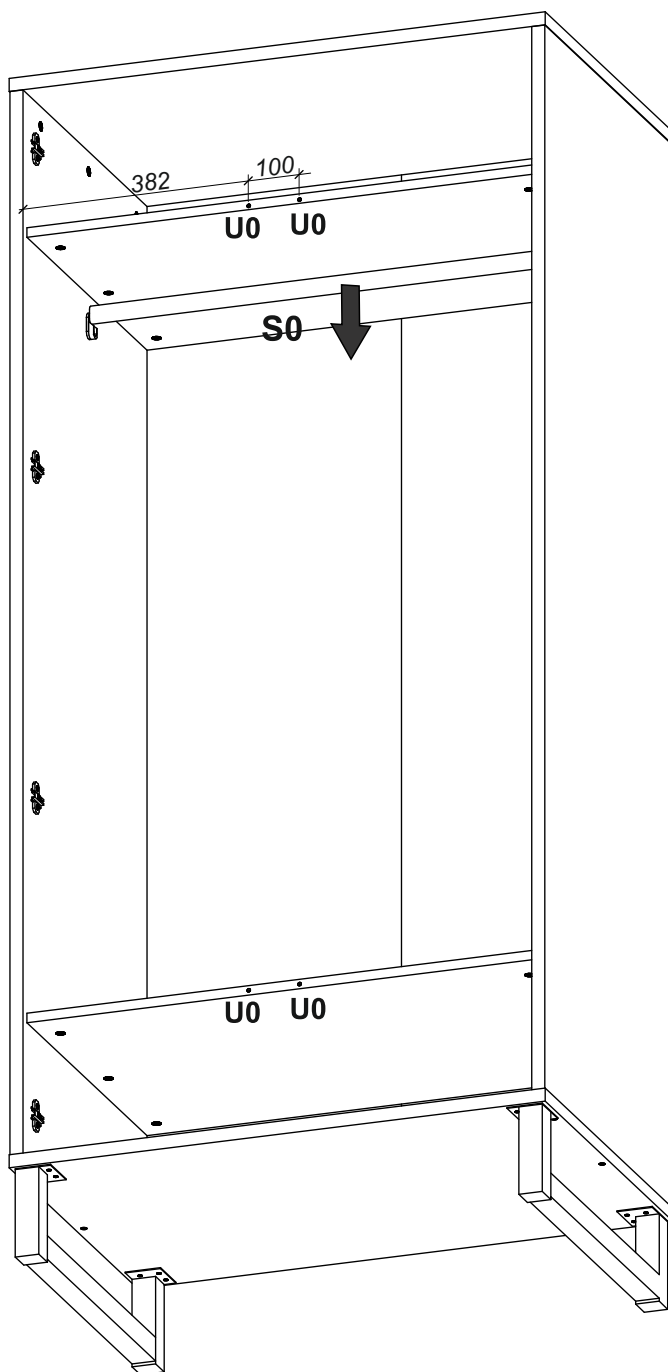

8

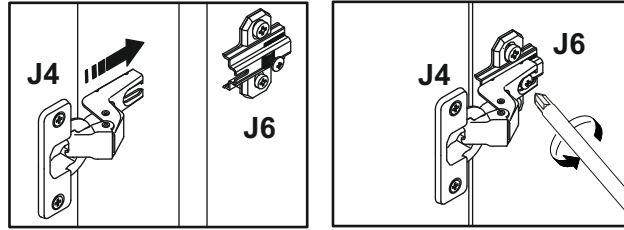

D5	E0	P0
3,5x16	8x50	
x2	x1	x1

